

Video Projector

Operating Instructions

HDMI[™]
HIGH-DEFINITION MULTIMEDIA INTERFACE

VPL-BW5

© 2008 Sony Corporation

WARNING

To reduce the risk of fire or electric shock, do not expose this apparatus to rain or moisture.

To avoid electrical shock, do not open the cabinet. Refer servicing to qualified personnel only.

WARNING

THIS APPARATUS MUST BE EARTHED.

IMPORTANT

The nameplate is located on the bottom.

WARNING

When installing the unit, incorporate a readily accessible disconnect device in the fixed wiring, or connect the power plug to an easily accessible socket-outlet near the unit. If a fault should occur during operation of the unit, operate the disconnect device to switch the power supply off, or disconnect the power plug.

CAUTION

Danger of explosion if battery is incorrectly replaced. Replace only with the same or equivalent type recommended by the manufacturer.

When you dispose of the battery, you must obey the law in the relative area or country.

For the customers in the U.S.A.

This equipment has been tested and found to comply with the limits for a Class B digital device, pursuant to Part 15 of the FCC Rules. These limits are designed to provide reasonable protection against harmful interference in a residential installation.

This equipment generates, uses, and can radiate radio frequency energy and, if not installed and used in accordance with the instructions, may cause harmful interference to radio communications. However, there is no guarantee that interference will not occur in a particular installation. If this equipment does cause harmful interference to radio or television reception, which can be

determined by turning the equipment off and on, the user is encouraged to try to correct the interference by one or more of the following measures:

- Reorient or relocate the receiving antenna.
- Increase the separation between the equipment and receiver.
- Connect the equipment into an outlet on a circuit different from that to which the receiver is connected.
- Consult the dealer or an experienced radio/TV technician for help.

You are cautioned that any changes or modifications not expressly approved in this manual could void your authority to operate this equipment.

All interface cables used to connect peripherals must be shielded in order to comply with the limits for a digital device pursuant to Subpart B of Part 15 of FCC Rules.

If you have any questions about this product, you may call:

Sony Customer Information Service Center
1-800-222-7669 or <http://www.sony.com/>

Declaration of Conformity

Trade Name: SONY

Model: VPL-BW5

Responsible Party: Sony Electronics Inc.

Address: 16530 Via Esprillo,
San Diego, CA 92127 U.S.A.

Telephone Number: 858-942-2230

This device complies with part 15 of the FCC Rules. Operation is subject to the following two conditions: (1) this device may not cause harmful interference, and (2) this device must accept any interference received, including interference that may cause undesired operation.

WARNING: THIS WARNING IS APPLICABLE FOR USA ONLY.

If used in USA, use the UL LISTED power cord specified below.

DO NOT USE ANY OTHER POWER CORD.

Plug Cap	Parallel blade with ground pin (NEMA 5-15P Configuration)
Cord	Type SJT, three 16 or 18 AWG wires
Length	Minimum 1.5m (4 ft .11 in.), Less than 4.5 m (14 ft .9 ⁵ / ₈ in.)
Rating	Minimum 10A, 125V

Using this unit at a voltage other than 120V may require the use of a different line cord or attachment plug, or both.

To reduce the risk of fire or electric shock, refer servicing to qualified service personnel.

Disposal of the used lamp

Lamp in this product contains mercury. Disposal of these materials may be regulated due to environmental considerations. For disposal or recycling information, please contact your local authorities or the Electronic Industries Alliance (www.eiae.org).

Für Kunden in Deutschland

Entsorgungshinweis: Bitte werfen Sie nur entladene Batterien in die Sammelboxen beim Handel oder den Kommunen. Entladen sind Batterien in der Regel dann, wenn das Gerät abschaltet und signalisiert „Batterie leer“ oder nach längerer Gebrauchsdauer der Batterien „nicht mehr einwandfrei funktioniert“. Um sicherzugehen, kleben Sie die Batteriepole z.B. mit einem Klebestreifen ab oder geben Sie die Batterien einzeln in einen Plastikbeutel.

For the customers in Taiwan only



廢電池請回收

Table of Contents

Precautions 5

Location of Controls

Top/Front/Side 6
Rear/Bottom 8
Remote Control 10

Connections and Preparations

Unpacking 12
Step 1: Installing the Projector 13
 Before Setting Up the Projector . 13
 Positioning the Projector and a
 Screen 16
Step 2: Connecting the Projector 18
 Connecting to a VCR 18
 Connecting to a Computer 21
Step 3: Adjusting the Picture
 Position 22
Step 4: Selecting the Menu
 Language 24

Projecting

Projecting the Picture on the Screen 26
 Turning Off the Power 27
Selecting the Wide Screen Mode 28
Selecting the Picture Viewing Mode 30
Adjusting the Picture Quality 31
Using Other Functions 32

Using the Menus

Operation through the Menus 33
PICTURE SETTING Menu 35
INPUT SETTING Menu 37

About the Preset Memory No.38
SET SETTING Menu39
MENU SETTING Menu41
INSTALL SETTING Menu42
INFORMATION Menu44
 Input Signals and Adjustable/
 Setting Items45

Others

Troubleshooting46
 Message Lists48
Replacing the Lamp49
Cleaning the Air Filter51
Specifications52
Installation Diagram56
 Floor Installation (Front
 Projection)56
 Ceiling Installation (Front
 Projection)58
Index62

Precautions

On safety

- Check that the operating voltage of your unit is identical with the voltage of your local power supply.
- Should any liquid or solid object fall into the cabinet, unplug the unit and have it checked by qualified personnel before operating it further.
- Unplug the unit from the wall outlet if it is not to be used for several days.
- To disconnect the cord, pull it out by the plug. Never pull the cord itself.
- The wall outlet should be near the unit and easily accessible.
- The unit is not disconnected to the AC power source (mains) as long as it is connected to the wall outlet, even if the unit itself has been turned off.
- Do not look into the lens while the lamp is on.
- Do not place your hand or objects near the ventilation holes. The air coming out is hot.
- Be careful not to get your fingers caught in the adjuster.
- Do not spread a cloth or paper under the unit.

On preventing internal heat build-up

After you turn off the power with the I/⏻ (On/standby) switch, do not disconnect the unit from the wall outlet while the cooling fan is still running.

Caution

The projector is equipped with ventilation holes (intake) and ventilation holes (exhaust). Do not block or place anything near these holes, or internal heat build-up may occur, causing picture degradation or damage to the projector.

On repacking

Save the original shipping carton and packing material; they will come in handy if you ever have to ship your unit. For

maximum protection, repack your unit as it was originally packed at the factory.

Cleaning the lens

The lens surface is especially treated to reduce reflection of light.

As incorrect maintenance may impair the performance of the projector, take care with respect to the following:

- Wipe the lens gently with a soft cloth such as a cleaning cloth or glass cleaning cloth.
- Stubborn stains may be removed with a soft cloth such as a cleaning cloth or glass cleaning cloth lightly dampened with water.
- Never use solvent such as alcohol, benzene or thinner, or acid, alkaline or abrasive detergent, or chemical cleaning cloth, as they will damage the lens surface.

Cleaning the cabinet

- To remove dust from the cabinet, wipe gently with a soft cloth. If dust is persistent, wipe with a soft cloth slightly moistened with a diluted mild detergent solution.
- Never use any type of abrasive pad, alkaline/acid cleaner, scouring powder, or volatile solvent, such as alcohol, benzene, thinner or insecticide.
- Using such materials or maintaining prolonged contact with rubber or vinyl materials may result in damage to the screen surface and cabinet material.

Black points and bright points (red, blue, or green) on the screen

The projector is manufactured using high-precision technology.

You may, however, see tiny black points and/or bright points (red, blue, or green) that continuously appear on the projector.

This is a normal result of the manufacturing process and does not indicate a malfunction.

Location of Controls

Top/Front/Side

You can use the buttons on the control panel with the same names as those on the remote control to operate the projector.

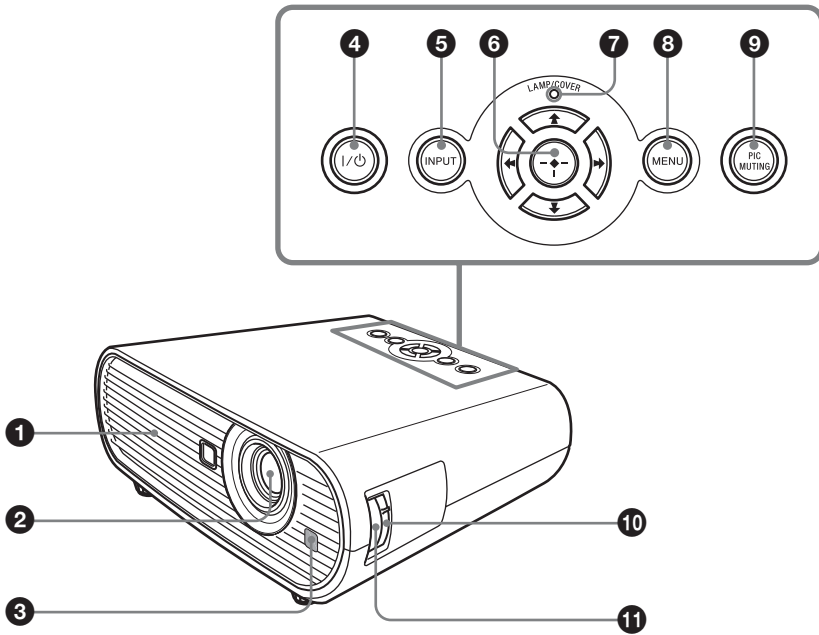

1 Ventilation holes (exhaust)**2 Lens**

Remove the lens cover before projection.

3 Front remote control detector**4 I/⏻ (On/standby) switch**

Turns on the projector when the projector is in standby mode. To turn off the power, press the I/⏻ switch twice according to the message or hold the I/⏻ switch for about one second.

The I/⏻ (On/standby) indicator lights up or flashes under the following conditions:

–Lights in red when the AC power cord is plugged into a wall outlet. Once the projector is in standby mode, you can turn it on with the I/⏻ switch.

–Flashes in red when the temperature becomes high inside the projector, or when the projector fails to operate.

–Lights in green when the power is turned on, and when it is ready to operate.

–Flashes in green until the projector is ready to operate after the projector is turned on. Also, flashes in green while the cooling fan is running after the power is turned off with the I/⏻ switch. The fan runs for about 90 seconds after the power is turned off. (📖 page 27)

–Lights in orange when the power saving mode is on.

5 INPUT button

Selects an input signal. The input signal will change whenever you press the button.

6 ↑/↓/←/→ (arrow) / Ⓜ (enter) buttons

Used to enter the settings of items in the menu system, select a menu, or make various adjustments.

7 LAMP/COVER indicators

Flashes in orange under the following conditions:

- A reception rate of 2 flashes when the lamp cover or air filter cover is not secured firmly.
- A reception rate of 3 flashes when the lamp has reached the end of its life or reaches a high temperature.

8 MENU button

Displays the on-screen menu. Press again to clear the menu.

9 PIC MUTING button

Cuts off the picture. Press again to restore the picture.

10 Zoom ring

Adjusts the picture size.

11 Focus ring

Adjusts the picture focus.

Rear/Bottom

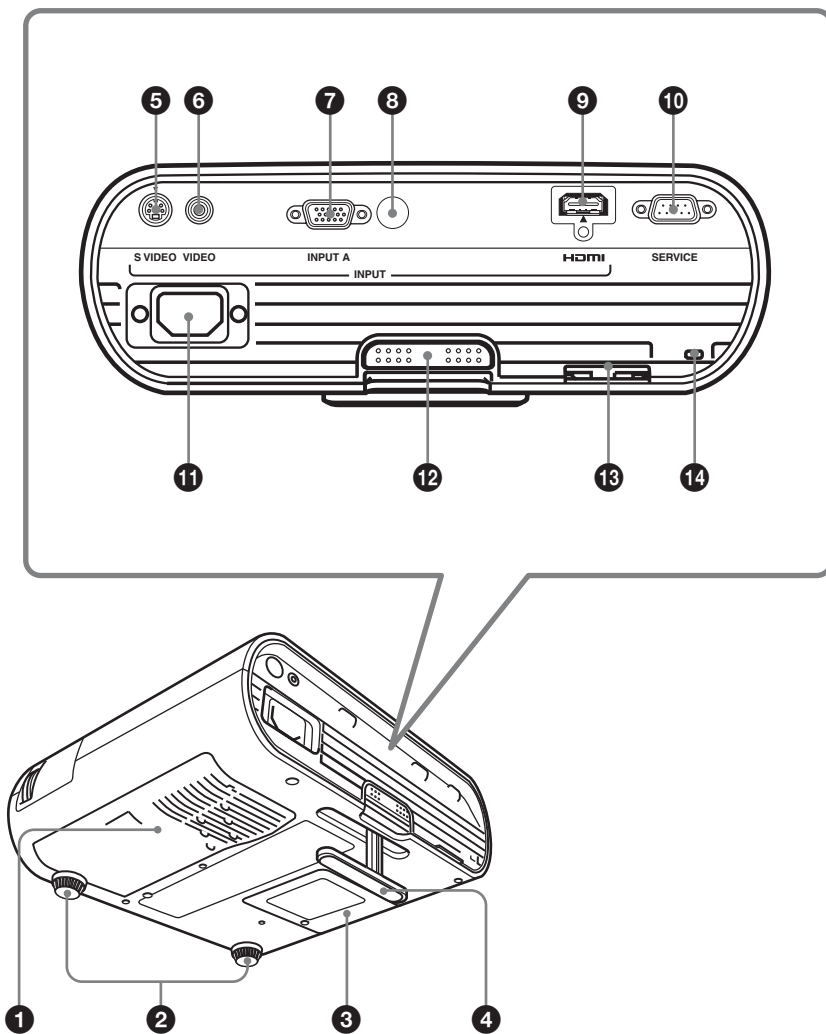

1 Ventilation holes (intake)/Air filter cover**2 Adjusters (fore pad)****3 Lamp cover****4 Adjuster**

Adjusts the picture position. (☞ page 23)

5 S VIDEO INPUT connector (mini DIN 4-pin)

Connects to the S video output of video equipment.

6 VIDEO INPUT connector (phono type)

Connects to the video output of video equipment.

7 INPUT A connector (HD D-sub 15-pin, female)

Inputs a computer signal, video GBR signal, component signal, or DTV signal depending on the connected equipment. Connects to the output connector of equipment using the supplied cable or an optional cable.

8 Rear remote control detector**9 HDMI connector**

Connects to the video output connector of the video equipment or the computer equipped with HDMI/DVI output connector (digital).

10 SERVICE RS-232C connector (D-sub 9-pin, female)

Used for service only.
This is not for customers' use.

11 AC IN socket

Connects the supplied AC power cord.

12 Adjuster adjustment button

Press to pull out the adjuster. (☞ page 23)

13 Security bar

An anti-theft chain or wire (commercially available) can be connected to this bar. If it is difficult to pull out, pull out the security bar using a screwdriver.

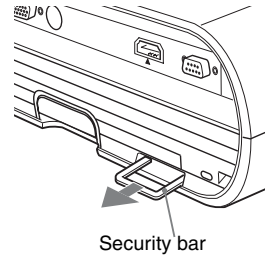
**14 Security lock**

Connects to an optional security cable (from Kensington).
Web page address:
<http://www.kensington.com/>

Note

To maintain optimal performance, **clean the air filter whenever you replace the lamp.** (☞ page 51)

Remote Control

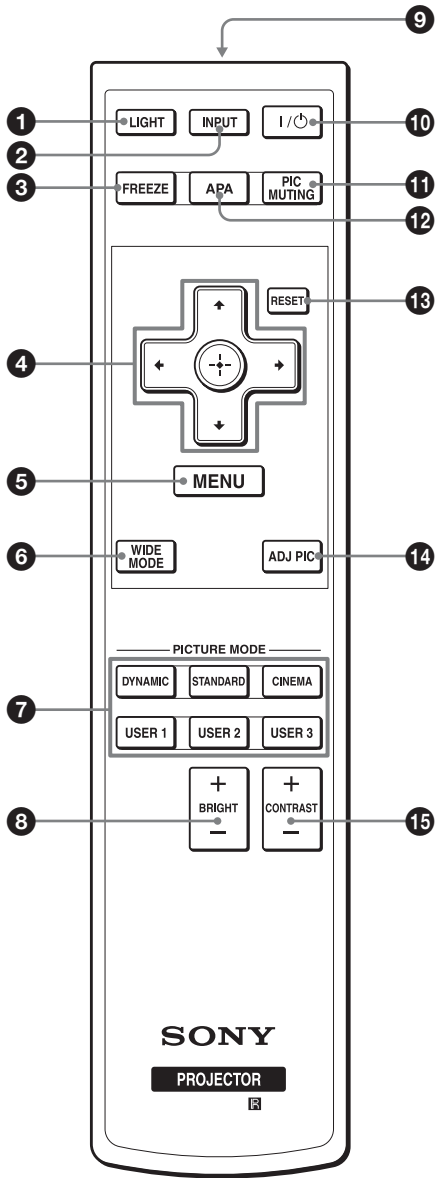

- 1 LIGHT button**
Illuminates the buttons on the remote control.
- 2 INPUT button**
- 3 FREEZE key**
Freezes the projected picture. To cancel the frozen picture, press the button again.
- 4 ↑/↓/←/→ (arrow)/ Ⓜ (enter) buttons**
- 5 MENU button**
- 6 WIDE MODE button**
Changes the wide screen modes according to the video signal received.
- 7 PICTURE MODE buttons**
Selects the picture viewing mode that best suits the type of picture or the environment.
- 8 BRIGHT +/- button**
Adjusts the brightness of the picture.
- 9 Infrared transmitter**
- 10 I/Ⓜ (On/standby) switch**
- 11 PIC MUTING button**
Cuts off the picture. Press again to restore the picture.
- 12 APA (Auto Pixel Alignment) button**
Automatically adjusts a picture to its clearest while a signal is input from a computer. (📖 page 39)
- 13 RESET button**
Resets the value of an item to its factory preset value. This button functions when the menu or a setting item is displayed on the screen.
- 14 ADJ PIC button**
Adjusts the picture quality by selecting the adjustment items.
- 15 CONTRAST +/- button**

Adjusts the white area of pictures (white level).

Connections and Preparations

This section describes how to install the projector and screen, how to connect the equipment from which you want to project the picture, etc.

Unpacking

Check the carton to make sure it contains the following items:

- Remote control (1) and Size AA (R6) batteries (2)

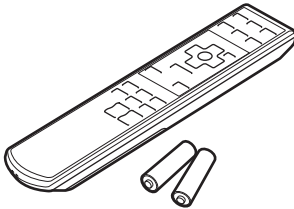

- AC power cord (1)
- Lens cap (1)
When you have purchased the projector, the lens cap was fitted onto the lens. Remove this lens cap when you use the projector.
- Signal cable (HD D-sub 15-pin ↔ 3 × phono plug) (1)
(9-885-125-47, SONY)
- Operating Instructions (this manual)
- Warranty card (1)

Inserting the batteries into the remote control

Push and slide to open.

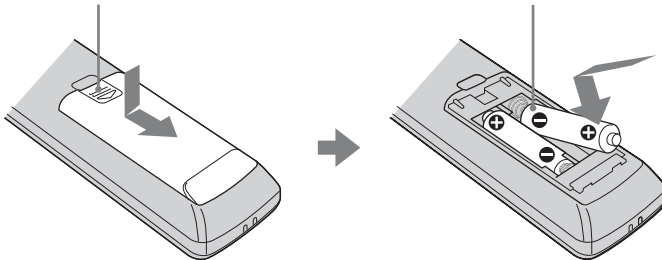

Insert the batteries  side first as shown in the illustration. Inserting them forcibly or with the polarities reversed may cause a short circuit and may generate heat.

Caution about handling the remote control

- Handle the remote control with care. Do not drop or step on it, or spill liquid of any kind onto it.
- Do not place the remote control in a location near a heat source, a place subject to direct sunlight, or a damp room.

Step 1: Installing the Projector

The projector displays pictures output from a VCR or other devices.

The projector can be used in various places and you can enjoy viewing beautiful pictures easily.

Before Setting Up the Projector

Unsuitable installation

Do not place the projector in the following situations, which may cause malfunction or damage to the projector.

Poorly ventilated location

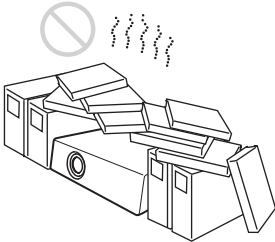

- Allow adequate air circulation to prevent internal heat build-up. Do not place the unit on surfaces (rugs, blankets, etc.) or near materials (curtains, draperies) that may block the ventilation holes. When internal heat builds up due to blockage of ventilation holes, the temperature sensor will function, and the power will be turned off automatically.
- Leave space of more than 30 cm (11 7/8 inches) around the unit.
- Be careful not to allow the ventilation holes to inhale tiny objects such as pieces of paper or clumps of dust.

Hot and humid

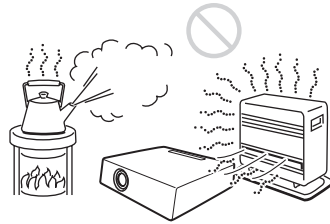

- Avoid installing the unit in a location where the temperature or humidity is very high, or the temperature is very low.
- To avoid moisture condensation, do not install the unit in a location where the temperature may rise rapidly.

Locations subject to direct cool or warm air from an air-conditioner

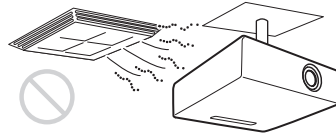

Installing the projector in such a location may cause a malfunction of the unit due to moisture condensation or rise in temperature.

Near a heat or smoke sensor

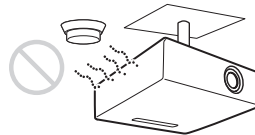

Malfunction of the sensor may occur.

Very dusty and extremely smoky locations

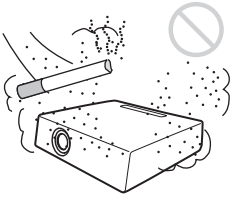

Avoid installing the unit in a very dusty or extremely smoky environment. Otherwise, the air filter will become obstructed, and this may cause a malfunction of the unit or damage it. Dust preventing the air passing through the filter may cause a rise in the internal temperature of the unit. Clean the air filter whenever you replace the lamp.

Unsuitable conditions

Do not use the projector under the following conditions.

Do not stand the unit upright on one side

Avoid using the unit standing upright on its side. It may cause malfunction.

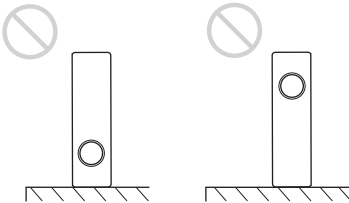

Do not tilt the unit to the right or left

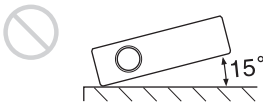

Avoid tilting the unit to an angle of 15°, and avoid installing the unit in any way other than placing it on a level surface or suspending from the ceiling. Such an installation may cause color shading or shorten the lamp life excessively.

Do not block the ventilation holes

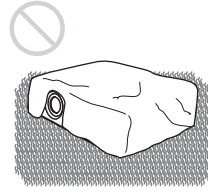

Avoid using a thick-piled carpet or anything that covers the ventilation holes (exhaust/intake); otherwise, internal heat may build up.

Do not place a blocking object just in front of the lens

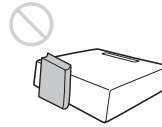

Do not place any object just in front of the lens that may block the light during projection. Heat from the light may damage the object. Use the PIC MUTING button to cut off the picture.

Do not use the security bar for transporting or installation

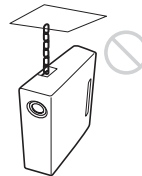

Use the Security bar at the rear of the projector for a purpose of preventing theft, by attaching a commercially available theft prevention cable for example. If you lift the projector by holding the Security bar, or hang the projector by using this bar, it may cause the projector to fall or be damaged.

Usage at high altitude

When using the projector at an altitude of 1,500 m or higher, turn on “High Altitude Mode” in the INSTALL SETTING menu. Failing to set this mode when using

the projector at high altitudes could have adverse effects, such as reducing the reliability of certain components.

Positioning the Projector and a Screen

The installation distance between the projector and a screen varies depending on the size of the screen.

1 Determine the installation position of the projector and screen.

Side view

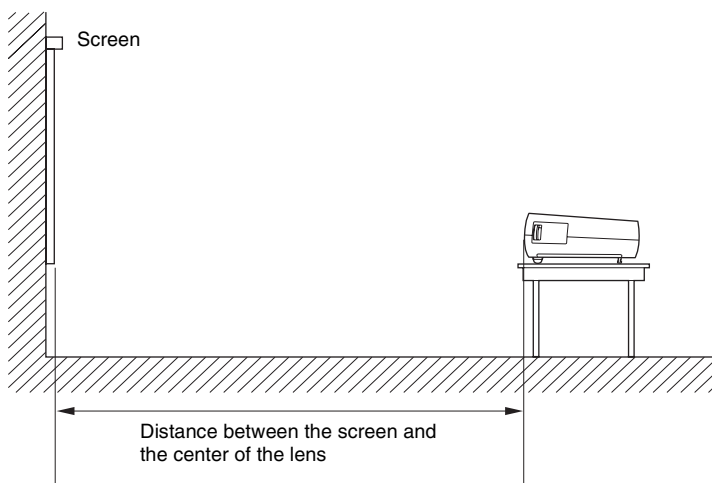

* Adjuster not stretched, and the V Keystone function has been done.

When “Wide Mode” in the INPUT SETTING menu is set to “Full 2”

Unit: m (feet)

Projected image size (diagonal) (inches)	40	80	100	150	200	250	300
Minimum Distance	1.2 (3.9)	2.5 (8.2)	3.1 (10.2)	4.6 (15.1)	6.2 (20.3)	7.7 (25.3)	9.3 (30.5)
Maximum Distance	1.5 (4.9)	2.9 (9.5)	3.7 (12.1)	5.6 (18.4)	7.4 (24.3)	9.3 (30.5)	11.1 (36.4)

There may be a slight difference between the actual value and the design value shown in the table above.

Notes on Wide Mode settings

- When “Wide Mode” in the INPUT SETTING menu is set to the mode other than “Full 2”, black bands may appear at the top and bottom or right and left of the screen.
- When “Wide Mode” in the INPUT SETTING menu is set to “4:3”, the projected image size (diagonal) will be approximately 88 % of “Full 2” size.
- When “Wide Mode” in the INPUT SETTING menu is set to “16:9”, the projected image size (diagonal) will be approximately 97 % of “Full 2” size.

For details on installation, see “Installation Diagram” on page 56.

2 Position the projector so that the lens is parallel to the screen.

Top view

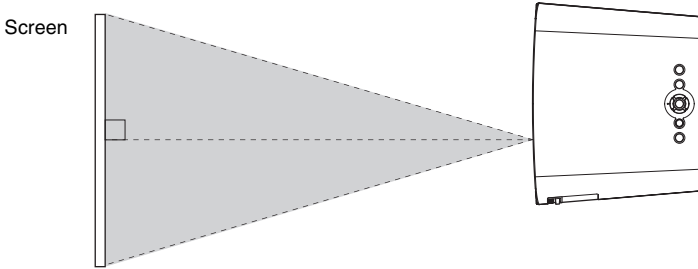

Note

When using a screen with an uneven surface, stripes pattern may rarely appear on the screen depending on the distance between the screen and the projector or the zooming magnifications. This is not a malfunction of the projector.

Step 2: Connecting the Projector

When making connections, be sure to do the following:

- Turn off all equipments before making any connections.
- Use the proper cables for each connection.
- Insert the cable plugs properly; poor connection at the plugs may cause a malfunction or poor picture quality. When pulling out a cable, be sure to pull it out with holding the plug, not the cable itself.
- Refer to the operating instructions of the connected equipment.

Connecting to a VCR

To connect to a DVD player/recorder and Blu-ray Disc player equipped with HDMI output

You can enjoy better picture quality by connecting a DVD player/recorder and Blu-ray Disc player equipped with HDMI output to the HDMI input of the projector.

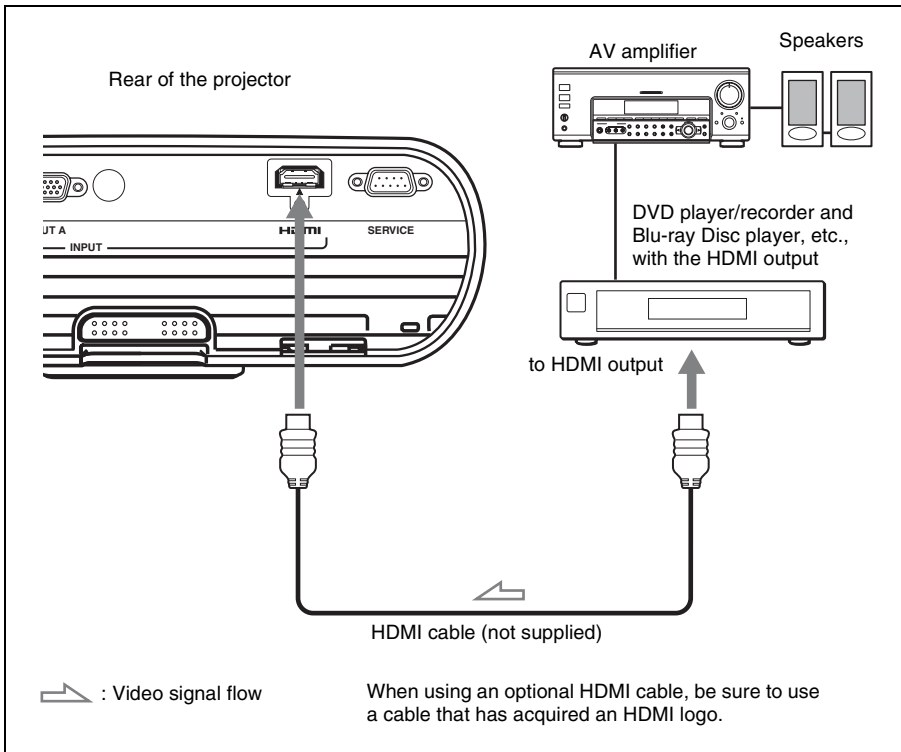

.....
This projector supports PC Display input of HDMI. It also supports HDCP.

Notes

- When connecting equipment to the HDMI input of the projector, be sure to use equipment that have acquired the HDMI logo.
- When connecting an HDMI cable to the projector, make sure the ▲ mark on the lower part of the HDMI input of the projector and the ▲ mark on the connector of the cable is set at the same position.
- If the picture from equipment connected to the projector with an HDMI cable is not clear, check the settings of the connected equipment.
- The HDMI connector of this projector is not compatible with DSD (Direct Stream Digital) Signal or CEC (Consumer Electronics control) Signal.

To connect to a DVD player/recorder, Blu-ray Disc player or digital tuner equipped with a video GBR/component video connectors

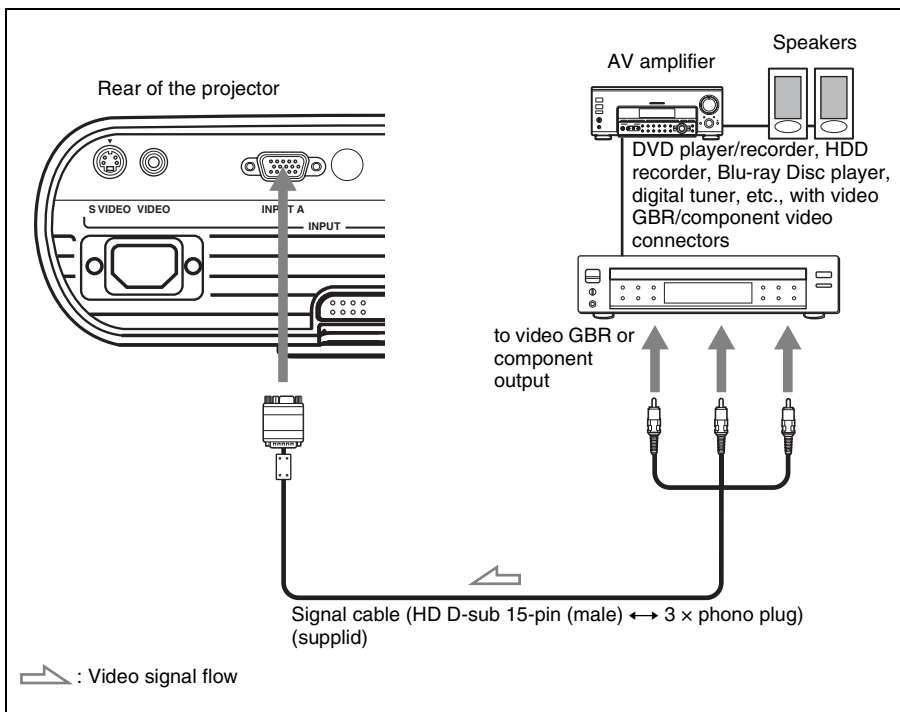

- Set the aspect ratio by pressing WIDE MODE on the remote control or using “Wide Mode” in the INPUT SETTING menu according to the input signal.
- When you connect the projector to a video GBR output connector, select “Video GBR” or when you connect the projector to component output connectors, select “Component” with the “Input-A Signal Sel.” setting in the SET SETTING menu.

To connect to a VCR equipped with the S video connector or video connector

You can connect a DVD player/recorder, hard disk video recorder, VCR or laser disk player, which is not equipped with component video connectors. See also the instruction manual of each equipment.

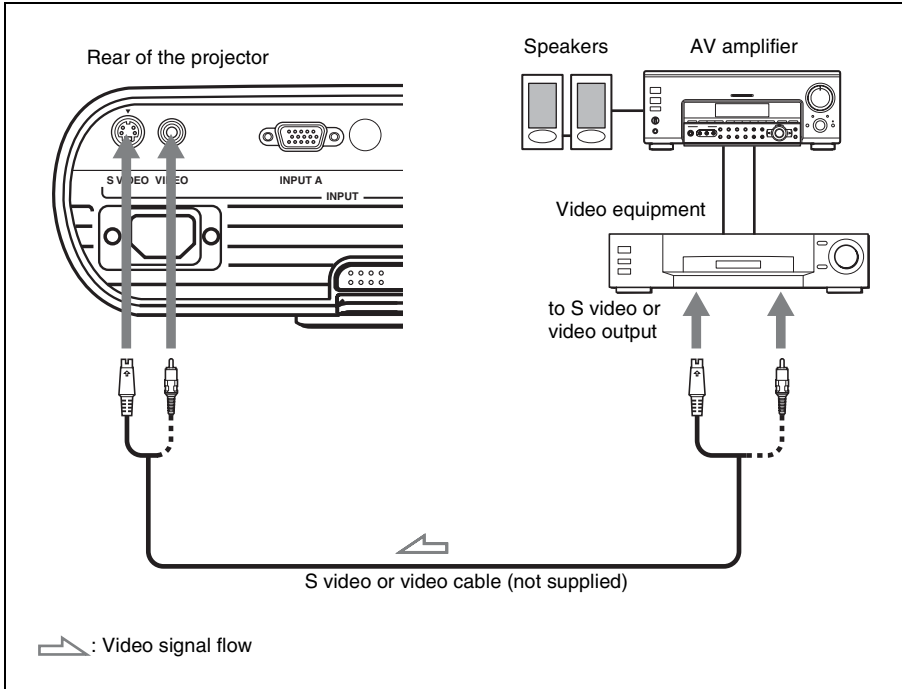

Tip

In order to enjoy better video performance, use S Video connector.

If the equipment to be connected has no S video connector, connect the cable to the video output.

Connecting to a Computer

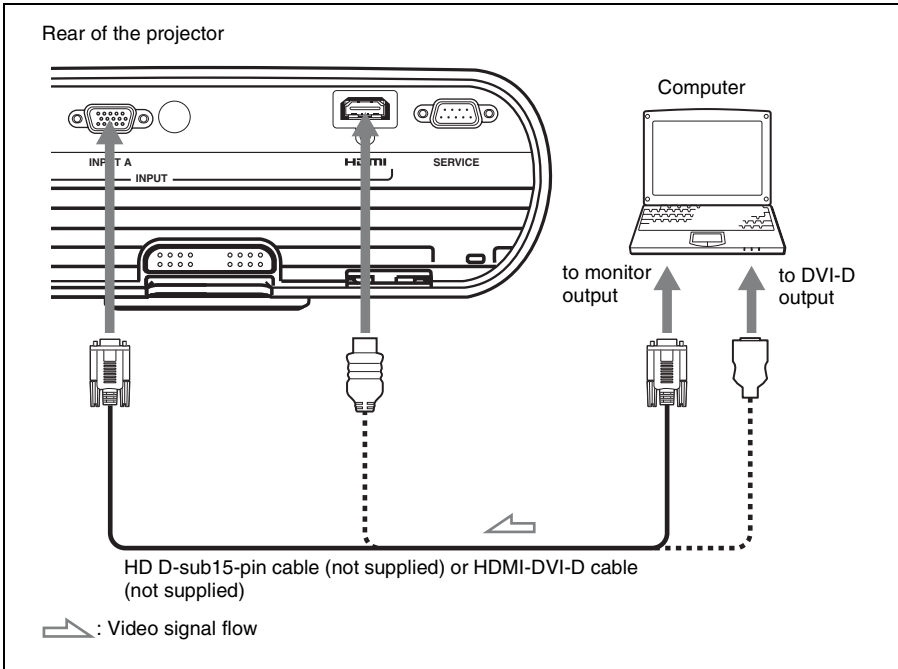

Tip

Set “Input-A Signal Sel.” in the SET SETTING menu to “Auto” or “Computer.” If the input signal does not appear properly, set it to “Computer.” (Ⓞ page 39)

Notes

- The projector accepts VGA, SVGA, XGA, SXGA, SXGA+, WXGA signals. However, we recommend that you set the output mode of your computer to WXGA mode for the external monitor.
- To connect a Macintosh computer equipped with a video output connector of a type having two rows of pins, use a commercially available plug adaptor.
- If you set your computer, such as a notebook type, to output the signal to both computer’s display and the external monitor, the picture of the monitor may not appear properly. Set your computer to output the signal only to the external monitor. For details, refer to the computer’s operating instructions supplied with your computer. For settings of the computer, consult with the manufacturer of the computer.
- The HDMI connector of this projector is not compatible with DSD (Direct Stream Digital) Signal or CEC (Consumer Electronics control) Signal.
- When connecting an HDMI cable to the projector, make sure the ▲ mark on the lower part of the HDMI input of the projector and the ▲ mark on the connector of the cable is set at the same position.

Step 3: Adjusting the Picture Position

Project an image on the screen and adjust the picture position.

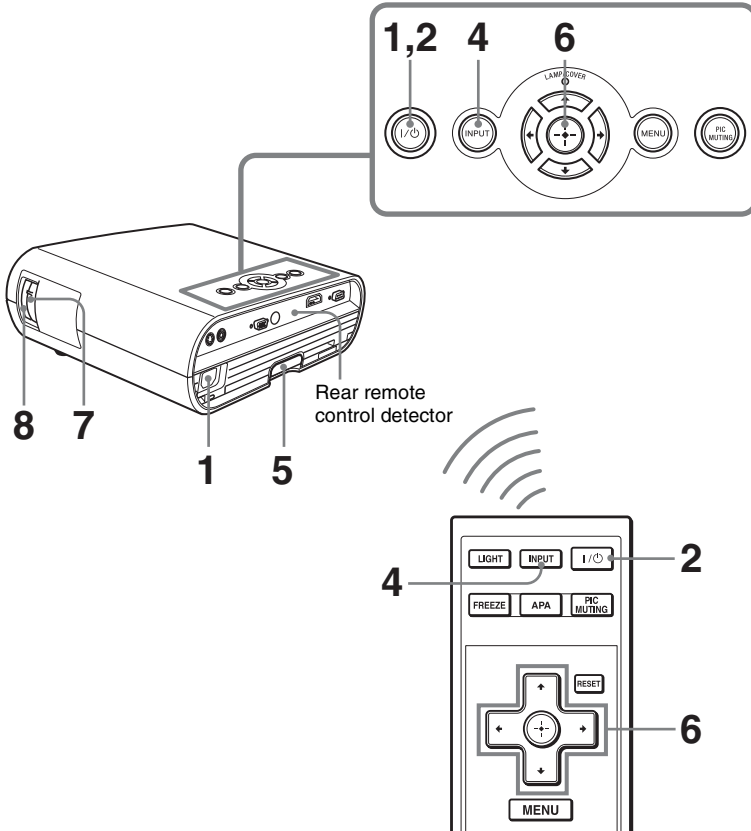

- 1 After connecting the AC cord to the projector, plug the AC cord into a wall outlet, connect all equipment, and remove the lens cover.**

The I/⏻ (On/standby) switch lights in red and the projector goes into standby mode.

- 2 Press the I/⏻ (On/standby) switch to turn on the projector.**

The I/⏻ (On/standby) switch flashes in green, then lights in green.

- 3 Turn on the equipment connected to the projector.**

Refer to the operating instructions of the connected equipment.

- 4 Press INPUT to project the picture on the screen.**

Each time you press the button, the input indication and equipment to be projected change. (ⓘ page 27)

Tips

- You can select the desired language for the menu screen. For details, refer to “Step 4: Selecting the Menu Language”. (🔗 page 24)
- When “Auto Input Search” is set to “On” in the SET SETTING menu, the input terminal with effective signals is automatically displayed by pressing INPUT. (🔗 page 39)

5 Adjust the upper or lower position of the picture.

Use the adjuster to adjust the picture position.

Using the adjuster

Lift the projector while pressing the adjuster adjustment button, and adjust the tilt of the projector, then release the button to lock the adjuster.

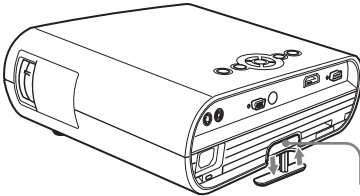

Adjuster adjustment button

Notes

- Be careful not to let the projector down on your fingers.
- Do not push hard on the top of the projector or do not drag it hard with the adjuster out. It may cause malfunction.

6 Adjust the trapezoidal distortion of the picture.

The V Keystone adjustment is performed automatically when you adjust the tilt of the projector with the adjuster. If you do not want to perform the keystone adjustment automatically, set “V Keystone” in the INSTALL SETTING menu to “Manual.” (🔗 page 42)

Note

If you set “V Keystone” to “Auto,” the V Keystone correction is automatically adjusted. However, it may not be perfectly

adjusted depending on the room temperature or the tilt of the screen. In this case, adjust it manually.

7 Adjust the picture size using the zoom lever.

8 Adjust the focus using the focus ring.

Step 4: Selecting the Menu Language

You can select one of 17 languages for displaying the menu and other on-screen displays. The factory default setting is English. To change the current menu language, set the desired language with the menu screen.

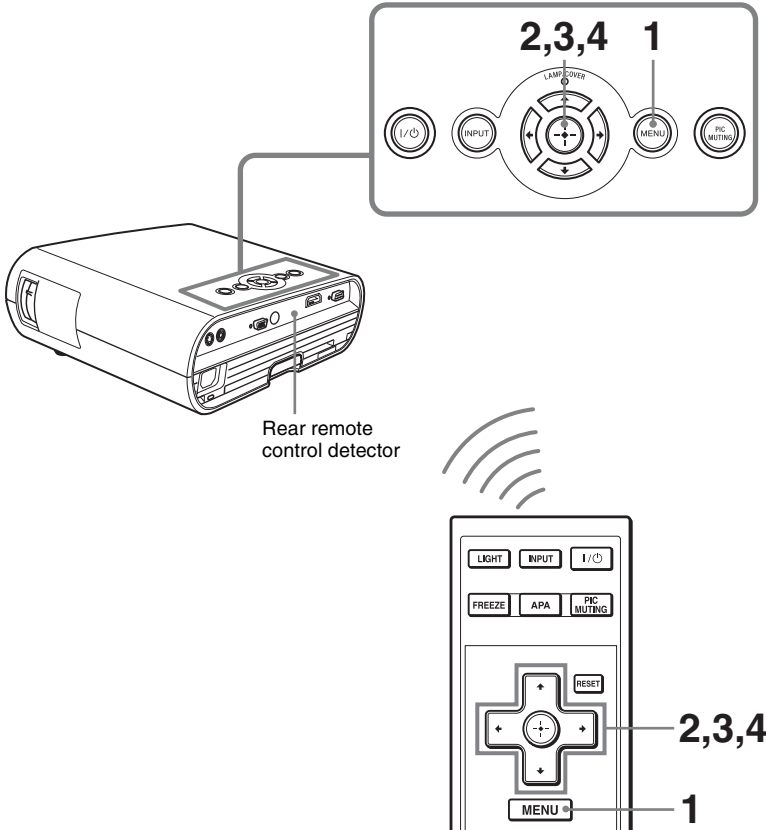

1 Press MENU.

The menu appears.

The menu currently selected is shown as a yellow button.

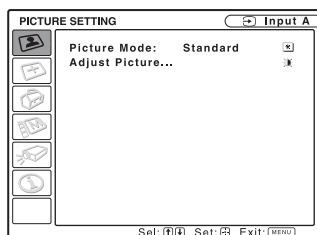

2 Press ↑/↓ to select the MENU SETTING menu, and press ⏏.

The setting items of the selected menu appears.

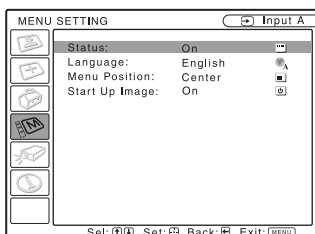

3 Press ↑/↓ to select “Language,” and press ⏏.

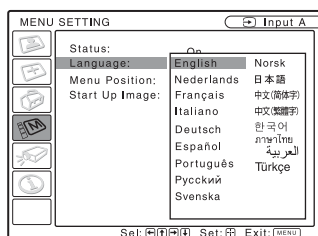

4 Press ↑/↓/←/→ to select a language, and press ⏏.

The menu changes to the selected language.

To clear the menu

Press MENU.

The menu disappears automatically if a button is not pressed for one minute.

Projecting

This section describes how to operate the projector to view the picture from the equipment connected to the projector. It also describes how to adjust the quality of the picture to suit your taste.

Projecting the Picture on the Screen

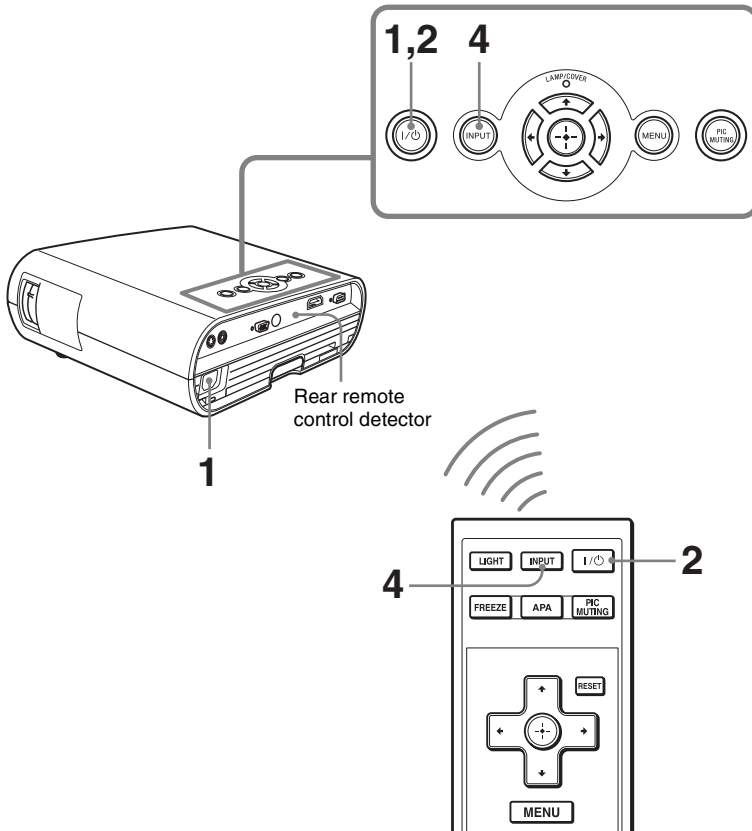

1 After connecting the AC cord to the projector, plug the AC cord into a wall outlet, connect all equipment, and remove the lens cover.

The I/O (On/standby) switch lights in red and the projector goes into standby mode.

2 Press the I/O (On/standby) switch to turn on the projector.

The I/⏻ (On/standby) switch flashes in green, then lights in green.

The projector cannot be used while the I/⏻ switch is flashing.

3 Turn on the equipment connected to the projector.

Refer to the operating instructions of the connected equipment.

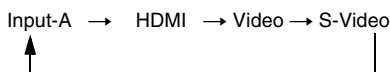

4 Press INPUT repeatedly to select the input you want to project on the screen.

Each time you press the button, you can select the input in the following sequence.



To view the picture from	Press INPUT to display
Computer/Component connected to the INPUT A connector	Input-A
Computer/VCR, etc. connected to HDMI (digital) connector	HDMI
Video equipment connected to the VIDEO INPUT connector	Video
Video equipment connected to the S VIDEO INPUT connector	S-Video

Notes

- If “Auto Input Search” is set to “On,” the projector searches for the signals from the connected equipment and displays the input channel where the input signals are found. (☞ page 39)
- When the analog signal is input from a computer, the Smart APA (Auto Pixel Alignment) feature adjusts the picture of the connected equipment to its clearest.
- Depending on the type of your computer, for example a notebook, or an all-in-one LCD type, you may have to switch the computer to output to the projector by pressing certain keys (e.g., , , etc.), or by

changing your computer’s settings.

The key used for switching the computer to output to the projector varies depending on the type of computer

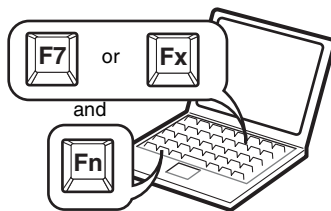

Turning Off the Power

1 Press the I/⏻ switch.

A message “POWER OFF? Please press I/⏻ switch again.” appears on the screen.

Note

The message disappears if you press any button other than the I/⏻ switch, or if you do not press any button for five seconds.

2 Press the I/⏻ switch again.

The I/⏻ switch flashes in green and the fan continues to run to reduce internal heat. Also, the I/⏻ switch flashes quickly for the first 60 seconds. During this time, you will not be able to light up the I/⏻ switch again with this switch.

3 Unplug the AC power cord from the wall outlet after the fan stops running and the I/⏻ switch lights in red.

Selecting the Wide Screen Mode

You can enjoy various wide screen modes according to the video signal received.

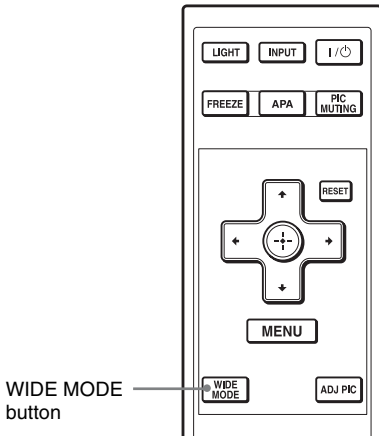

WIDE MODE button

Press WIDE MODE.

Each time you press the button, you can change the “Wide Mode” setting in turn.

You can also select it using the menu. (☞ page 37)

Wide Zoom (When the SD signal is input)

A 4:3 aspect ratio picture is enlarged over the entire screen properly. The upper and lower portions of the screen are slightly cut off.

Original image

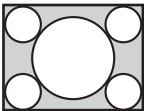

When the Wide Mode is operated

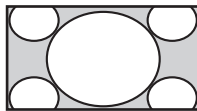

Normal

A picture with normal 4:3 aspect ratio is displayed in the center of the screen to fill the vertical screen size.

Original image

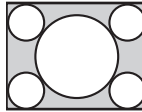

When the Wide Mode is operated

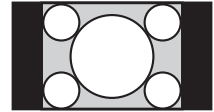

Full

A picture squeezed to 4:3 is displayed with the correct aspect ratio. A 4:3 picture is enlarged horizontally to fit the 16:9 screen.

Original image Squeezed

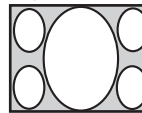

When the Wide Mode is operated

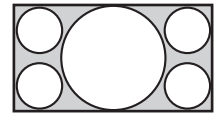

Tip

Squeezed: An original 16:9 aspect ratio picture is recorded horizontally compressed to a 4:3 picture.

Zoom (When the SD or PC signal is input)

A normal 16:9 aspect ratio picture is enlarged vertically and horizontally in the same ratio to fill the screen. Use this mode to view a letterbox picture or a letterbox picture with side panels.

Original image

Letterbox picture with side panels



Letterbox picture

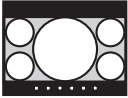

When the Wide Mode is operated

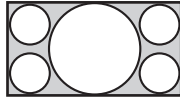

Full 1 (When the PC signal is input)

Displays a picture on the whole of the screen without changing the aspect ratio of the original picture.

Original image

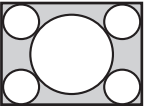

When the Wide Mode is operated

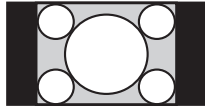

Full 2 (When the PC signal is input)

Displays a picture on the whole of the screen.

Original image

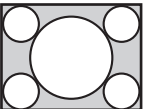

When the Wide Mode is operated

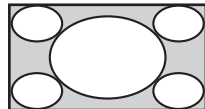

Notes

- Changing the aspect ratio of the original picture will provide a different look from that of the original image.
- Note that if the projector is used for profit or for public viewing, modifying the original picture by switching to the wide mode may constitute an infringement of

the rights of authors or producers, which are legally protected.

Selecting the Picture Viewing Mode

You can select the picture viewing mode that best suits the type of program or room conditions.

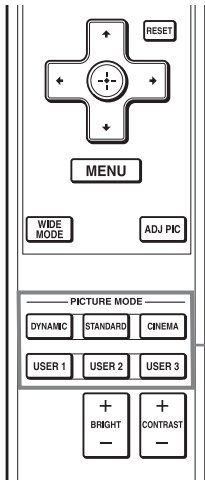

PICTURE
MODE buttons
DYNAMIC
STANDARD
CINEMA
USER 1,
USER 2 and
USER 3

Press one of the PICTURE MODE buttons (DYNAMIC, STANDARD, CINEMA and USER 1, USER 2 and USER 3).

DYNAMIC

The picture becomes bright suitable for viewing the picture in a bright room.

STANDARD

The quality of the picture becomes more natural than the one selected by “DYNAMIC.”

CINEMA

Recommended when viewing a movie in a dark place.

USER 1, USER 2 and USER 3

You can adjust the quality of the picture to suit your taste and store the settings into the selected memory of the projector.

Press one of the USER 1, USER 2 and USER 3 buttons, then adjust the picture by using the buttons on the remote control or the menus. (☞ pages 31 and 35)

The settings are stored, and you can view the picture with the adjusted picture quality by pressing the button.

Adjusting the Picture Quality

You can adjust the picture quality that suits your taste by selecting the adjustment items with the remote control. The adjusted data can be stored in each picture mode.

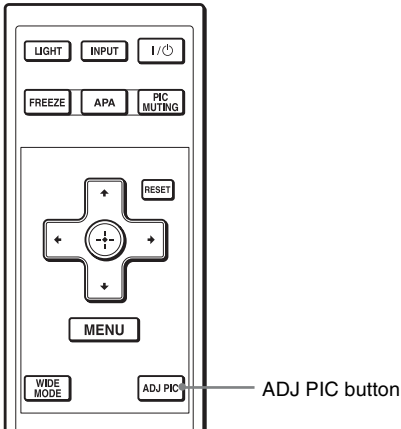

1 Press ADJ PIC.

Each time you press the button, the following adjustment windows* are displayed in sequence.

* Some of the adjustment windows will not be displayed depending on the input signal. For details, see “Input Signals and Adjustable/Setting Items.” (☞ page 45)

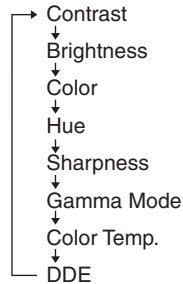

For details on each adjustment, see the PICTURE SETTING menu. (☞ page 35)

2 Make the setting or adjustment on an item.

When changing the adjustment level

To increase the value, press **→**.

To decrease the value, press **←**.

When changing the setting

Press **↑/↓** to change the setting.

Using Other Functions

You can temporarily turn off or pause a projected picture.

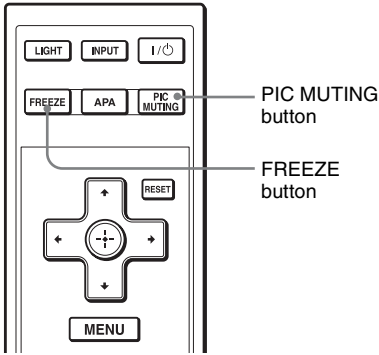

Press PIC MUTING.

Press to temporarily turn off a projected picture. To return to the previous screen, press PIC MUTING again.

Press FREEZE.

A projected picture can be paused to be displayed. "FREEZE" is shown on the screen when a button is pressed. To return to the previous screen, press FREEZE again.

Note

The FREEZE function is available for only computer signal.

Using the Menus

This section describes how to make various adjustments and settings using the menus.

Operation through the Menus

The projector is equipped with an on-screen menu for making various adjustments and settings. Some of the adjustable/setting items are displayed in a pop-up menu, in an adjustment menu with no main menu, or in the next menu window. If you select an item name followed by dots (...), the next menu window with setting items appears. To change the on-screen menu language, see “Step 4: Selecting the Menu Language”. (☞ page 24)

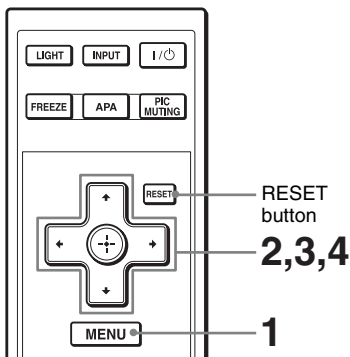

Display items

The input signal and input signal setting indicators are displayed on the upper right corner of the menu window.

Input signal indicator

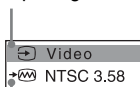

Input signal setting indicator

Input signal indicator

Shows the selected input channel. x(Video) is displayed when no signal is input. You can hide this indicator using “Status” in the MENU SETTING menu.

Input signal setting indicator

When Input-A is selected: Shows “Auto” or “Input-A Signal Sel.” setting in the SET SETTING menu.

When Video or S-Video is selected: Shows “Auto” or the “Color System” setting in the SET SETTING menu.

1 Press MENU.

The menu window appears.

The menu presently selected is shown as a yellow button in the column on the left.

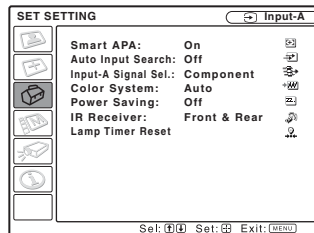

2 Press ↑/↓ to select a menu, and press → or (Center).

The items that can be set or adjusted with the selected menu appear.

3 Press ↑/↓ to select an item you want to set or adjust and press → or (Center).

The items that can be set appear in the pop-up menu, adjustment menu, or in the next menu window.

Pop-up menu

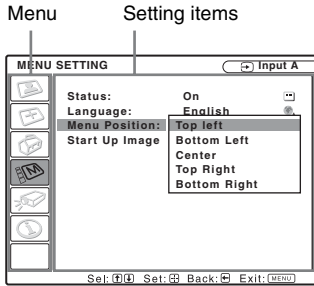

Adjustment menu



Next menu window

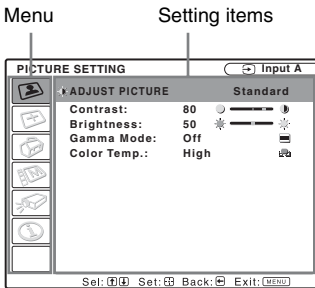

4 Make the setting or adjustment of an item.

When changing the adjustment level

To increase the value, press \uparrow/\rightarrow .

To decrease the value, press \downarrow/\leftarrow .

Press \odot to restore the previous screen.

When changing the setting

Press \uparrow/\downarrow to change the setting.

Press \odot to restore the previous screen.

You can restore the previous screen using \leftarrow depending on the selected item.

Items that cannot be adjusted

Adjustable items differ depending on the input signal. The items that cannot be adjusted or set do not appear in the menu. (☞ page 45)

To clear the menu

Press MENU.

The menu disappears automatically if a button is not pressed for one minute.

To reset the items that have been adjusted

Select an item that you want to reset, then press RESET on the remote control.

The message “Complete!” appears on the screen and the setting of the item that you have selected is reset to its factory preset value.

Items that can be reset are:

- “Contrast,” “Brightness,” “Color,” “Hue” and “Sharpness” in the “Adjust Picture...” menu of the PICTURE SETTING menu
- “Dot Phase,” “H Size,” and “Shift” in the “Adjust Signal...” menu of the INPUT SETTING menu

Storage of the settings

The settings are automatically stored in the projector memory when the \odot button is pressed.

If no signal is input

If there is no input signal, the message “Cannot adjust this item.” appears on the screen.

PICTURE SETTING Menu

The PICTURE SETTING menu is used for adjusting the picture.

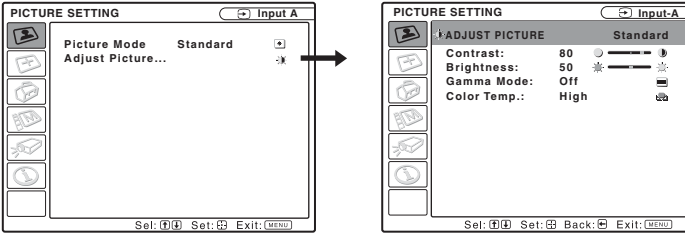

Setting items	Functions	Initial setting
Picture Mode	<p>You can select the picture viewing mode that best suits the type of picture or the environment.</p> <p>Dynamic: Select this for bright picture suitable for viewing it in a bright room.</p> <p>Standard: Select this for more natural picture than the picture with the Dynamic setting.</p> <p>Cinema: Select this for watching movies, etc. in a dark environment.</p> <p>User 1, User 2, User 3: You can adjust the quality of the picture to suit your taste and then store the settings. Once the settings are stored, you can view the picture with the adjusted picture quality by pressing PICTURE MODE on the remote control.</p> <p>To store the settings</p> <ol style="list-style-type: none"> 1 Select User 1, User 2, or User 3. 2 Adjust the items you want in the menus. <p>Tips</p> <ul style="list-style-type: none"> • You can also adjust the picture quality in “Dynamic”, “Standard” or “Cinema”, and store the settings. To reset everything to the factory settings, select “Picture Mode,” and press RESET on the remote control. • Some items may not be displayed in the PICTURE SETTING menu, depending on the type of input signal. For details, see “Input Signals and Adjustable/Setting Items” (☞ page 45). 	Set according to the input signal
Adjust Picture...	The projector can store the setting values of the following menu items for each picture mode separately.	
Contrast	<p>Adjusts the white area of pictures (white level).</p> <p>The higher the setting, the greater the contrast. The lower the setting, the lower the contrast.</p> <p>You can make adjustments by pressing CONTRAST+/- on the remote control.</p>	80

Setting items	Functions	Initial setting
Brightness	Adjusts the brightness of the picture. The higher the setting, the brighter the picture. The lower the setting, the darker the picture. You can make adjustments by pressing BRIGHT+/- on the remote control.	50
Color	Adjusts the intensity of the color density. The higher the setting, the greater the intensity. The lower the setting, the lower the intensity.	50
Hue	Adjusts the color tone. The higher the setting, the more greenish the picture becomes. The lower the setting, the more reddish the picture becomes.	50
Sharpness	Sharpens the outline of the picture, or reduces the noise. The higher the setting, the sharper the picture. The lower the setting, the softer the picture, thus reducing the noise.	30
Gamma Mode	Adjusts the response characteristics of the tone of the picture. Select a favorite tone from three options. Gamma1: Makes a scene a little brighter. Gamma2: Makes a scene brighter. Gamma3: Makes a scene darker. Off: Gamma Mode is "Off".	Off
Color Temp.	Adjusts the color temperature. High: Gives white colors a blue tint. Middle: Gives a neutral tint between "High" and "Low". Low: Gives white colors a red tint.	Set according to the input signal
DDE (Dynamic Detail Enhancer)	According to the film source you have selected, make a setting for playback. Off: Plays a video signal in an interlace format without converting. Progressive: Converts an interlace format video signal to a progressive format. Film: Normally, select this option. Reproduces the 2-3 Pull-Down film sources with smooth picture movement. When the video signal with a format other than the 2-3 Pull-Down is input, "Progressive" is automatically selected.	Film

INPUT SETTING Menu

The INPUT SETTING menu is used to adjust the input signal.

When the signal is input from a computer

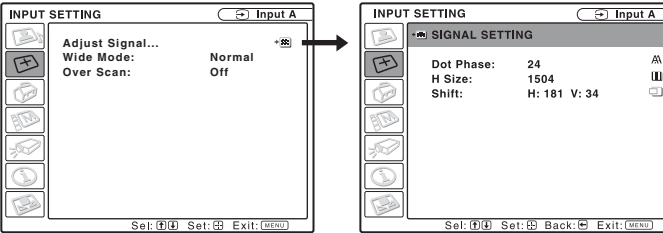

Setting items	Functions	Initial setting
Adjust Signal...		
Dot Phase	<p>Adjusts the dot phase of the LCD panel and the signal output from a computer.</p> <p>Adjust the picture further for finer picture after the picture is adjusted by pressing the APA key.</p>	Set according to the input signal
H Size	<p>Adjusts the horizontal size of a picture output from a computer.</p> <p>Adjust the setting according to the dots of the input signal. (☞ page 54)</p>	Set according to the input signal
Shift	<p>Adjusts the position of the picture.</p> <p>H: As the setting for H (horizontal) increases, the picture moves to the right, and as the setting decreases, the picture moves to the left. Use ←/→ to adjust the horizontal position.</p> <p>V: As the setting for V (vertical) increases, the picture moves up, and as the setting decreases, the picture moves down. Use ↑/↓ to adjust the vertical position.</p>	Set according to the input signal
Wide Mode (When the video signal is input)	<p>You can set the aspect ratio of the picture to be displayed for the current input signal. This item is enabled only when an video signal (preset memory numbers 1 to 11) is input.</p> <p>Normal: A picture with normal 4:3 aspect ratio is displayed in the center of the screen to fill the vertical screen size.</p> <p>Full: A picture squeezed to 4:3 is displayed with the correct aspect ratio. A 4:3 picture is enlarged horizontally to fit the 16:9 screen.</p> <p>Zoom: A normal 16:9 aspect ratio picture (SD signal only) is enlarged vertically and horizontally in the same ratio to fill the screen.</p> <p>Wide Zoom: A 4:3 aspect ratio picture (SD signal only) is enlarged over the entire screen properly. The upper and lower portions of the screen are slightly cut off.</p>	Set according to the input signal

Setting items	Functions	Initial setting
Wide Mode (When the PC signal is input)	<p>You can set the aspect ratio of the picture to be displayed for the current input signal. This item is enabled only when an PC signal (preset memory numbers 21 to 63) is input.</p> <p>Full 1: Displays a picture on the whole of the screen without changing the aspect ratio of the original picture.</p> <p>Full 2: Displays a picture on the whole of the screen.</p> <p>Normal: Displays the picture while matching one pixel of input picture element to that of the LCD. The picture will be clear but the picture size will be smaller.</p> <p>Zoom: A normal 16:9 aspect ratio picture is enlarged vertically and horizontally in the same ratio to fill the screen.</p>	Set according to the input signal
Over Scan	<p>Hides the outer edges of the picture.</p> <p>On: Hides the outer edges of the input picture. Select this setting when noise appears along the edge of the picture.</p> <p>Off: Projects the whole of the input picture.</p>	On

Notes

- Some of the “Wide Mode” setting items are not displayed on the screen according to the input signal.
- Note that if the projector is used for profit or for public viewing, modifying the original picture by switching to the wide mode may constitute an infringement of the rights of authors or producers, which are legally protected.

About the Preset Memory No.

This projector has 45 types of preset data for input signals (the preset memory). When a preset signal is input, the projector automatically detects the signal type and recalls the data for the signal from the preset memory to adjust it to an optimum picture. The memory number and signal type of that signal are displayed on the INFORMATION menu (ⓘ page 44). You can also adjust the preset data through the INPUT SETTING menu.

See the chart on page 54 to find if the signal is registered in the preset memory.

Note

When the aspect ratio of input signal is other than “Full 2”, a part of the screen may be displayed in black.

SET SETTING Menu

The SET SETTING menu is used for changing the settings of the projector.

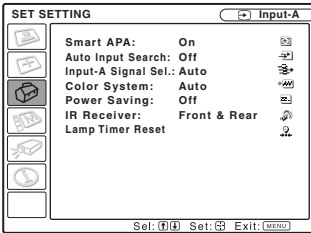

Setting items	Functions	Initial setting
Smart APA	<p>The APA (Auto Pixel Alignment) automatically adjusts “Dot Phase,” “H Size” and “Shift” in the INPUT SETTING menu for the input signal from a computer.</p> <p>On: When a signal is input from a computer, the APA functions automatically so that the picture can be seen clearly. Once the specified input signal has been adjusted by the “Smart APA,” it will not be readjusted even when the cable is disconnected and connected again or the input channel is changed. You can adjust the picture by pressing APA on the remote control even if “Smart APA” is set to “On.”</p> <p>Off: APA functions only when you press APA on the remote control.</p>	On
Auto Input Search	<p>Detects the input signal and displays the detected input signal automatically when the INPUT button is pressed.</p> <p>When set to “On,” the projector detects input signals in the following order: Input-A, HDMI, Video and S-Video. It indicates the input channel when the power is turned on or the INPUT button is pressed.</p>	Off
Input-A Signal Sel.	<p>Selects the type of signal input from the equipment connected to the INPUT A connector.</p> <p>Selects the type of signal input from the equipment by selecting “Input-A” with the INPUT button.</p> <p>Auto: Selects the input signal type automatically.</p> <p>Computer: Inputs the signal from a computer.</p> <p>Component: Inputs the component signal from a DVD player/recorder, Blu-ray Disc player, digital tuner, etc.</p> <p>Video GBR: Inputs the signal from a TV game or HDTV broadcast.</p>	Auto

Setting items	Functions	Initial setting
Color System	Selects the color system of the input signal. If you select "Auto," the projector detects the color system of the input signal automatically. If the picture is distorted or colorless, select the color system according to the input signal.	Auto
Power Saving	Selects the Power Saving mode. Lamp off: The lamp goes off if no signal is input for 10 minutes. The lamp lights again when a signal is input or any button is pressed. Standby: The projector goes into Standby mode if no signal is input for 10 minutes. To use it, turn on the power again. Off: The projector does not go into Power Saving mode.	Off
IR Receiver	Selects the remote control detectors (IR Receiver) on the front and rear of the projector. Front & Rear: Activates both the front and rear detectors. Front: Activates the front detector only. Rear: Activates the rear detector only.	Front & Rear
Lamp Timer Reset	When replacing the lamps, reset the lamp timer.	–

Notes

- Press APA when the full image is displayed on the screen. If the projected image includes a black portion around it, the APA function will not work properly and some parts of the image may not be displayed on the screen.
 - You can cancel the adjustment by pressing APA again while "Adjusting" appears on the screen.
 - The picture may not be adjusted properly depending on the type of input signal.
 - Adjust the "Dot Phase," "H Size," and "Shift" items in the INPUT SETTING menu when you adjust the picture manually.
- If the input signal is not displayed correctly when "Input-A Signal Sel." is set to "Auto," set it to conform the input signal.

MENU SETTING Menu

The MENU SETTING menu is used for changing the menu displays.

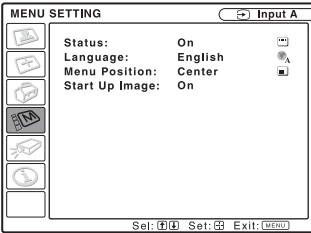



Setting items	Functions	Initial setting
Status (on-screen display)	Sets whether or not the on-screen display is displayed. Set to “Off” to turn off the on-screen displays except for the menus, message when turning off the power, and warning messages.	On
Language	Selects the language used in the menu and on-screen displays. The languages available are: English, Nederlands, Français, Italiano, Deutsch, Español, Português, Русский, Svenska, Norsk, 日本語, 中文(简体字), 中文(繁體字), 한국어, ગુજરાતી, العربية, and Türkçe.	English
Menu Position	Selects the display position of the menu. You can select from “Top Left,” “Bottom Left,” “Center,” “Top Right,” and “Bottom Right.”	Bottom Left
Start Up Image	Sets whether or not the start-up image is displayed after the projector is turned off. On: Displays the Start Up Image in the window after turning on the power. Off: Does not display the Start Up Image in the window after turning on the power.	On

INSTALL SETTING Menu

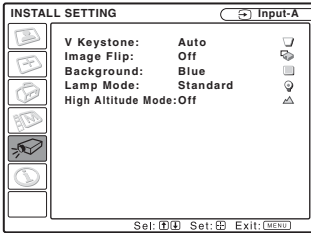
The INSTALL SETTING menu is used for changing the settings of the projector.



Setting items	Functions	Initial setting
V Keystone	<p>Corrects the trapezoidal distortion caused by the projection angle.</p> <p>Select “Auto” for automatic correction, or “Manual” for manual correction using the ↑/↓/←/→ buttons.</p> <p>When the bottom of the trapezoid is longer than the top  : Sets a lower value.</p> <p>When the top of the trapezoid is longer than the bottom  : Sets a higher value.</p>	Auto
Image Flip	<p>Flips the image on the screen horizontally and/or vertically.</p> <p>HV: Flips the image horizontally and vertically.</p> <p>H: Flips the image horizontally.</p> <p>V: Flips the image vertically.</p> <p>Off: The image does not flip.</p>	Off
Background	<p>Selects the background color of the screen when no signal is input.</p> <p>Select “Black” or “Blue.” Normally, set to “Blue.”</p>	Blue
Lamp Mode	<p>Sets the lamp brightness used during the projection.</p> <p>High: Illuminates the projected image brightly.</p> <p>Standard: Reduces fan noise and power consumption. The brightness of the projected image will be lower compared with the “High” setting.</p>	Standard
High Altitude Mode	<p>Set to “On” when the projector is used at an altitude of 1,500 m or higher.</p>	Off

Notes

- The picture quality may deteriorate when the V Keystone function is used, because it is an electrical correction.
- If you set “High Altitude Mode” to “On” at an altitude of under 1,500 m, the reliability of the lamp may be reduced.
- The auto V Keystone adjustment may not correct the trapezoidal distortion perfectly, depending on the room temperature or the screen angle.

INFORMATION Menu

The INFORMATION menu displays the model name, serial number, the horizontal and vertical frequencies of the input signal and the cumulated hours of usage of the lamp.

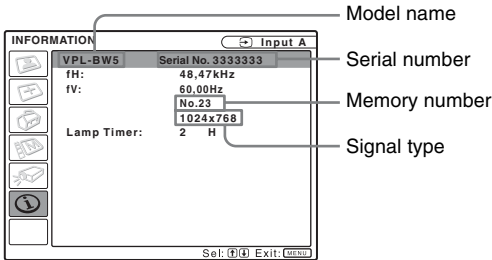

Model name	Displays the model name.
Serial number	Displays the serial number.
fH (horizontal frequency)	Displays the horizontal frequency of the input signal.
fV (vertical frequency)	Displays the vertical frequency of the input signal.
Memory number	Displays the preset memory number of the input signal.
Signal type	Displays the type of the input signal.
Lamp Timer	Indicates how long the lamp has been turned on (total usage).

Notes

- fH (horizontal frequency) and fV (vertical frequency) may not be displayed depending on the input signal used on the projector.
- You cannot change any items listed above.

Input Signals and Adjustable/Setting Items

Some of the items in the menus cannot be adjusted depending on the input signal as indicated in the following tables. The items that cannot be adjusted are not displayed in the menu.

PICTURE SETTING menu

Item	Input signal				
	Video or S-Video (Y/C)	Component	Video GBR	Computer	HDMI
Picture Mode	●	●	●	●	●
Adjust Picture...					
Contrast	●	●	●	●	●
Brightness	●	●	●	●	●
Color	●	●	●	–	●
Hue	● (NTSC 3.58/ 4.43 only)	●	●	–	–
Sharpness	●	●	●	–	●
Gamma Mode	●	●	●	●	●
Color Temp.	●*2	●*2	●*2	●*2	●*2
DDE	●	● (Interlace format only)*1	● (Interlace format only)*1	–	● (Interlace format only)*1

● : Adjustable/can be set

– : Not adjustable/cannot be set

*1: Except for preset memory No. 7, 8

*2: Cannot be set in the Dynamic mode

INPUT SETTING menu

Item	Input signal				
	Video/S-Video (Y/C)	Component	Video GBR	Computer	HDMI
Wide Mode	●	●	●	●*3	●
Adjust Signal...					
Dot Phase	–	–	–	●	–
H size	–	–	–	●	–
Shift	–	●	●	●	–
Over Scan	–	●	●	–	●

● : Adjustable/can be set

– : Not adjustable/cannot be set

*3: Can be set except preset memory number 49.

Others

This section describes how to solve the problems, how to replace the lamp and air filter, etc.

Troubleshooting

If the projector appears to be operating erratically, try to diagnose and correct the problem using the following instructions. If the problem persists, consult with qualified Sony personnel.

Power

Symptom	Cause and Remedy
The power is not turned on.	<ul style="list-style-type: none">• The power has been turned off and on with the I/O switch at a short interval. → Wait for about 90 seconds before turning on the power (☞ page 27).• The lamp cover is not secured. → Close the lamp cover securely (☞ page 49).• The air filter cover is detached. → Attach the air filter cover securely (☞ page 51).

Picture

Symptom	Cause and Remedy
No picture.	<ul style="list-style-type: none">• A cable is disconnected or the connections are wrong. → Check that the proper connections have been made (☞ page 18).• The connections are wrong. → This projector is compatible with DDC2B (Digital Data Channel 2B). If your computer is compatible with DDC, turn the projector on according to the following procedures. 1 Connect the projector to the computer. 2 Turn the projector on. 3 Start the computer.• Input selection is incorrect. → Select the input source correctly (☞ page 27).• The picture is muted. → Press PIC MUTING to release the picture muting (☞ page 32).• The computer signal is not set to output to an external monitor or set to output both to an external monitor and a LCD monitor of a computer. → Set the computer signal to output only to an external monitor (☞ page 21).

Symptom	Cause and Remedy
The picture is noisy.	Noise may appear on the background depending on the combination of the number of dots input from the computer and the numbers of pixels on the LCD panel. → Change the desktop pattern on the connected computer.
The picture from the INPUT A connector is colored strange.	The input signal cannot be received at “Auto” of “Input-A Signal Sel” in the SET SETTING menu, or the setting of “Input-A Signal Sel” is incorrect. → Selects “Computer”, “Video GBR” or “Component” correctly according to the input signal (☞ page 39).
On-screen display does not appear.	“Status” in the MENU SETTING menu has been set to “Off.” → Set “Status” in the MENU SETTING menu to “On” (☞ page 41).
Color balance is incorrect.	<ul style="list-style-type: none"> • The picture has not been adjusted properly. → Adjust the picture (☞ page 31). • The projector is set to the wrong color system. → Set “Color System” in the SET SETTING menu to match the color system being input (☞ page 40).
The picture is too dark.	<ul style="list-style-type: none"> • Contrast or brightness has not been adjusted properly. → Adjust the contrast or brightness in the “Adjust Picture...” menu properly (☞ page 35). • The lamp has burnt out or is dim. → Replace the lamp with a new one (☞ page 49).
The picture is not clear.	<ul style="list-style-type: none"> • The picture is out of focus. → Adjust the focus using the focus ring (☞ page 23). • Condensation has accumulated on the lens. → Leave the projector for about two hours with the power on.
The image extends beyond the screen.	<ul style="list-style-type: none"> • The APA button has been pressed even though there are black edges around the image. → Display the full image on the screen and press APA. → Adjust “Shift” in the INPUT SETTING menu properly (☞ page 37). • The input signal cannot be projected as the frequency is out of the acceptable range of the projector. → Input a signal that is within the range of the frequency. • The resolution setting of the output signal of the computer is too high. → Set the output setting to WXGA (☞ page 21).
The picture flickers.	“Dot Phase” in the INPUT SETTING menu has not been adjusted properly. → Adjust “Dot Phase” in the INPUT SETTING menu properly (☞ page 37).

Remote control

Symptom	Cause and Remedy
The remote control does not work.	Batteries are dead. → Replace them with new batteries (☞ page 12).

Indicators

Symptom	Cause and Remedy
The LAMP/COVER indicator flashes in orange. (Repetition rate of 2 flashes)	<ul style="list-style-type: none"> The lamp cover or the air filter cover is detached. → Attach the cover securely (☞ pages 49 and 51).
The LAMP/COVER indicator flashes in orange. (Repetition rate of 3 flashes)	<ul style="list-style-type: none"> The lamp has reached the end of its life. → Replace the lamp (☞ page 49). The lamp has reached a high temperature. → Wait for 60 seconds until the lamp cools, then turn on the power again.
⏻ switch flashes in red. (Repetition rate of 2 flashes)	<ul style="list-style-type: none"> The internal temperature is unusually high. → Check to ensure that nothing is blocking the ventilation holes. The projector is being used at a high altitude. → Ensure that “High Altitude Mode” in the INSTALL SETTING menu is set to “On.”
⏻ switch flashes in red. (Repetition rate of 4 flashes)	<p>The fan is broken.</p> <p>→ Consult with qualified Sony personnel.</p>
⏻ switch flashes in red. (Repetition rate of 6 flashes)	<p>Unplug the AC power cord from the wall outlet after the ⏻ switch stops flashing, plug the power cord to the wall outlet, then turn the projector on again. If the ⏻ switch flashes in red and the problem persists, the electrical system has failed.</p> <p>→ Consult with qualified Sony personnel.</p>

Message Lists

Warning Message

Message	Meaning and Remedy
Please replace the Lamp and clean the Filter.	<ul style="list-style-type: none"> It is time to replace the lamp and clean the air filter. → Replace the lamp (☞ page 49) and clean the filter (☞ page 51). When this message appears even after replacing the lamp, the task has not been completed. → Perform the operation of steps 10 to 13 on page 50.

Caution Message

Message	Meaning and Remedy
Not applicable!	<p>You have pressed the wrong button.</p> <p>→ Press the appropriate button.</p>

Replacing the Lamp

The lamp used as a light source is consumable product. Thus replace the lamp with a new one in the following cases.

- When the lamp has burnt out or dims
- “Please replace the Lamp and clean the Filter” appears on the screen
- The LAMP/COVER indicator lights up (repeats flashing three times)

The lamp life varies depending on conditions of use.

Use an LMP-E190 Projector Lamp as the replacement lamp.

Use of any other lamps than the LMP-E190 may cause damage to the projector.

Notes

- If the lamp breaks, ask qualified Sony personnel to replace the lamp and to check inside.
- Pull out the lamp by holding the handle.
- When removing the lamp, make sure it remains horizontal, then pull straight up. Do not tilt the lamp. If you pull out the lamp while tilted and if the lamp breaks, the pieces may scatter, causing injury.

1 Turn off the projector, and disconnect the AC power cord from the AC outlet.

Note

When you replace the lamp after using the projector, wait for at least an hour for the lamp to cool.

2 Place a protective sheet (cloth) beneath the projector. Turn the projector over so you can see its underside.

Note

Be sure that the projector is placed on a stable surface.

3 Loosen the screw with a Phillips screwdriver, then open the lamp cover.

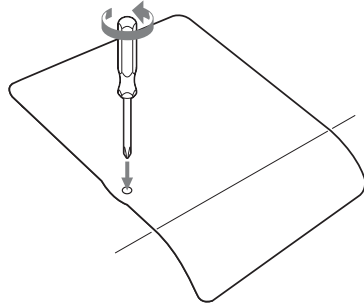

Note

For safety reasons, do not loosen any other screws.

4 Loosen the two screws on the lamp unit with the Phillips screwdriver (1). Fold out the handle (2), then pull out the lamp unit by the handle (3).

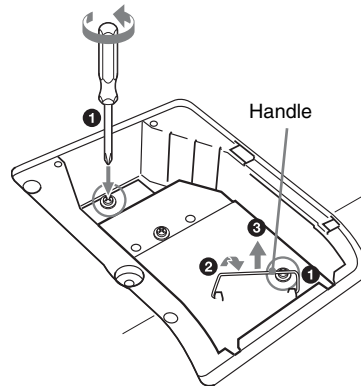

5 Insert the new lamp all the way in until it is securely in place (1). Tighten the two screws (2). Fold down the handle to replace it (3).

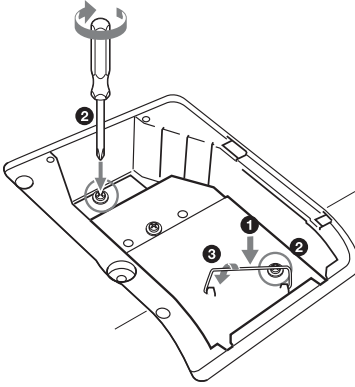

Notes

- Be careful not to touch the glass surface of the lamp.
- The power will not turn on if the lamp is not secured properly.
- Do not allow any liquid or other objects into the slot to avoid electrical shock or fire.

6 Close the lamp cover and tighten the screw.

Note

Be sure to attach the lamp cover securely as it was. If not, the projector cannot be turned on.

7 Turn the projector back over.

8 Connect the power cord.

The I/O switch lights in red.

9 Press the I/O switch to turn the projector on.

10 Press MENU, and select the SET SETTING menu.

11 Select “Lamp Timer Reset”, and press \odot .

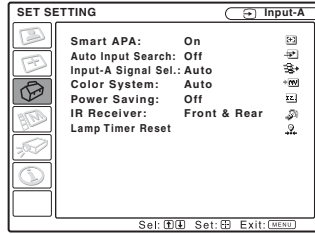

12 Select “Execute” with \downarrow , and press \odot .

The Lamp Timer is initialized to 0, and “Change the Lamp and clean the Filter?” is displayed in the menu screen.

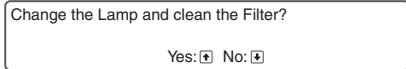

Refer to page 51 for “Cleaning the Air Filter”.

13 Select “Yes” with \uparrow .

“Lamp Timer Reset Complete!” is displayed in the menu screen.

Disposal of the used lamp

Lamp in this product contains mercury. Disposal of these materials may be regulated due to environmental considerations. For disposal or recycling information, please contact your local authorities or the Electronic Industries Alliance (www.eiae.org).

Cleaning the Air Filter

The air filter should be cleaned whenever you replace the lamp. Remove the air filter, and then remove the dust with a vacuum cleaner. The time needed to clean the air filter will vary depending on the environment or how the projector is used.

When it becomes difficult to remove the dust from the filter with a vacuum cleaner, remove the air filter and wash it.

- 1 Turn the power off and unplug the power cord.**
- 2 Draw out the air filter cover and remove it.**

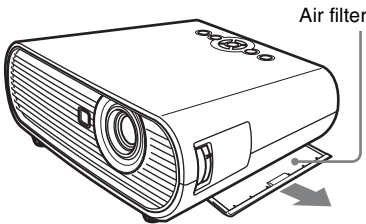

- 3 Remove the air filter.**

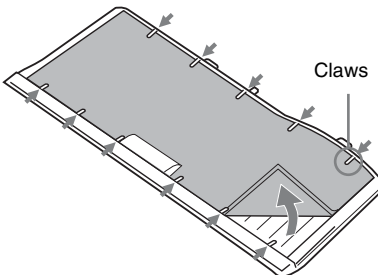

- 4 Wash the air filter with a mild detergent solution and dry it in a shaded place.**
- 5 Attach the air filter so that it fits securely into each claw on the**

air filter cover and replace the cover.

Notes

- **If you neglect to clean the air filter, dust may accumulate, clogging it. As a result, the temperature may rise inside the unit, leading to a possible malfunction or fire.**
- Be sure to attach the air filter cover firmly; the power can not be turned on if it is not closed securely.
- The air filter has a face and a reverse side. Place the air filter so that it fits in a notch on the air filter cover.

Specifications

Optical characteristics

Projection system

3 LCD panels, 1 lens, projection system

LCD panel 0.59-inch vWXGA panel, about 3,070,000 pixels (1280 × 800 × 3)

Lens 1.2 times zoom lens
f 18.53 to 22.18 mm/F1.65 to 1.93

Lamp 190 W Ultra high pressure lamp

Projected picture size
40 to 300 inches (measured diagonally)

Light output¹⁾ 2000 lm

¹⁾ When the Lamp Mode is set to “High.”

Throwing distance²⁾

40-inch: 1.2 to 1.5 m
(3.9 to 4.9 feet)

80-inch: 2.5 to 2.9 m
(8.2 to 9.5 feet)

100-inch: 3.1 to 3.7 m
(10.2 to 12.1 feet)

150-inch: 4.6 to 5.6 m
(15.1 to 18.4 feet)

200-inch: 6.2 to 7.4 m
(20.3 to 24.3 feet)

250-inch: 7.7 to 9.3 m
(25.3 to 30.5 feet)

300-inch: 9.3 to 11.1 m
(30.5 to 36.4 feet)

²⁾ When placed on the floor, the adjuster not stretched, the V Keystone function has been done, and “Wide Mode” in the INPUT SETTING menu is set to “Full 2.”

There may be a slight difference between the actual value and the design value shown above.

Electrical characteristics

Color system NTSC^{3.58}/PAL/SECAM/
NTSC^{4.43}/PAL-M/PAL-N/
PAL60 system, switched
automatically/manually
(NTSC^{4.43} is the color system
used when playing back a video
recorded in NTSC on a
NTSC^{4.43} system VCR.)

Resolution 750 horizontal TV lines (video
input)
1280 × 800 dots (RGB input)

Acceptable computer signals³⁾
fH: 19 to 92 kHz
fV: 48 to 92 Hz

(Maximum input signal resolution:
SXGA+ 1400 × 1050
fV: 60 Hz)

³⁾ Set the resolution and the frequency of the signal of the connected computer within the range of acceptable preset signals of the projector.

Applicable video signals

15 k RGB/component 50/60 Hz,
Progressive component 50/60
Hz, DTV (480/60i, 575/50i,
480/60p, 575/50p, 720/60p,
720/50p, 1080/60i, 1080/50i),
Composite video, Y/C video

Input/Output

VIDEO IN VIDEO: phono type
Composite video: 1 Vp-p ±2 dB
sync negative (75 ohms
terminated)

S VIDEO: Y/C mini DIN 4-
pintype

Y (luminance): 1 Vp-p ±2 dB
sync negative (75 ohms
terminated)

C (chrominance): burst 0.286
Vp-p ±2 dB (NTSC) (75 ohms
terminated), burst 0.3 Vp-p ±2
dB (PAL) (75 ohms terminated)

INPUT A RGB: HD D-sub15-pin (female)

Analog RGB/component:
R/R-Y: 0.7 Vp-p ±2 dB (75
ohms terminated)

G: 0.7 Vp-p ±2 dB (75 ohms
terminated)

G with sync/Y: 1 Vp-p ±2 dB
sync negative (75 ohms
terminated)

B/B-Y: 0.7 Vp-p ±2 dB (75
ohms terminated)

HD: Horizontal sync input: TTL
level, positive/negative

VD: Vertical sync input: TTL
level, positive/negative

HDMI Digital RGB/Y Cb (Pb) Cr (Pr)
SERVICE RS-232C: D-sub 9 pin

General

Dimensions 314 × 109 × 269 mm (12 ³/₈ ×
4 ³/₈ × 10 ⁵/₈ inches) (w/h/d)
(without projecting parts)

Mass Approx. 3.0 kg (6 lb 10 oz)

Power requirements
AC 100 to 240 V, 2.6 to 1.1 A, 50/
60 Hz

Power consumption
Max. 260 W (in standby: 3 W)

Heat dissipation

884 BTU

Operating temperature

0°C to 35°C (32°F to 95°F)

Operating humidity

35% to 85% (no condensation)

Storage temperature

-20°C to +60°C (-4°F to +140°F)

Storage humidity

10% to 90%

Supplied accessories

Remote control (1)

Size AA (R6) batteries (2)

Signal cable (HD D-sub 15-pin

↔ 3 × phono plug) (1)

(9-885-125-47, SONY)

AC power cord (1)

Lens cap (1)

Operating Instructions (1)

Warranty card (1)

Design and specifications are subject to change without notice.

Optional accessory

Projector Lamp

LMP-E190 (for replacement)

Some of the items may not be available in some areas. For details, please consult your nearest Sony dealer.

Pin assignment

INPUT A connector (HD D-sub 15-pin, female)

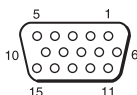

1	R/R-Y	9	Power supply input for DDC
2	G/Y	10	GND
3	B/B-Y	11	GND
4	RESERVE	12	DDC/SDA
5	GND	13	HD
6	GND (R)	14	VD
7	GND (G)	15	DDC/SCL
8	GND (B)		

Preset Signals

Memory No.	Preset signal		fH (kHz)	fV (Hz)	Sync
1	Video 60 Hz	60 Hz	15.734	59.940	–
2	Video 50 Hz	50 Hz	15.625	50.000	–
3	480/60i	480/60i	15.734	59.940	S on G/Y
4	575/50i	575/50i	15.625	50.000	S on G/Y
5	480/60p	480/60p (Progressive component NTSC)	31.470	60.000	S on G/Y
6	575/50p	575/50p (Progressive component PAL)	31.250	50.000	S on G/Y
7	1080/60i	1035/60i, 1080/60i	33.750	60.000	S on G/Y
8	1080/50i	1080/50i	28.130	50.000	S on G/Y
10	720/60p	720/60p	45.000	60.000	S on G/Y
11	720/50p	720/50p	37.500	50.000	S on G/Y
21	640 × 350	VGA mode 1	31.469	70.086	H-pos, V-neg
22		VGA VESA 85 Hz	37.861	85.080	H-pos, V-neg
23	640 × 400	PC-9801 Normal	24.823	56.416	H-neg, V-neg
24		VGA mode 2	31.469	70.086	H-neg, V-pos
25		VGA VESA 85 Hz	37.861	85.080	H-neg, V-pos
26	640 × 480	VGA mode 3	31.469	59.940	H-neg, V-neg
27		Macintosh 13"	35.000	66.667	H-neg, V-neg
28		VGA VESA 72 Hz	37.861	72.809	H-neg, V-neg
29		VGA VESA 75 Hz	37.500	75.000	H-neg V-neg
30		VGA VESA 85 Hz	43.269	85.008	H-neg V-neg
31	800 × 600	SVGA VESA 56 Hz	35.156	56.250	H-pos, V-pos
32		SVGA VESA 60 Hz	37.879	60.317	H-pos, V-pos
33		SVGA VESA 72 Hz	48.077	72.188	H-pos, V-pos
34		SVGA VESA 75 Hz	46.875	75.000	H-pos, V-pos
35		SVGA VESA 85 Hz	53.674	85.061	H-pos, V-pos
36	832 × 624	Macintosh 16"	49.724	74.550	H-neg, V-neg
37	1024 × 768	XGA VESA 60 Hz	48.363	60.004	H-neg, V-neg
38		XGA VESA 70 Hz	56.476	70.069	H-neg, V-neg
39		XGA VESA 75 Hz	60.023	75.029	H-pos, V-pos
40		XGA VESA 85 Hz	68.677	84.997	H-pos, V-pos
41	1152 × 864	SXGA VESA 70 Hz	63.995	70.019	H-pos, V-pos
42		SXGA VESA 75 Hz	67.500	75.000	H-pos, V-pos
43		SXGA VESA 85 Hz	77.487	85.057	H-pos, V-pos

Memory No.	Preset signal		fH (kHz)	fV (Hz)	Sync
44	1152 × 900	Sunmicro LO	61.795	65.960	H-neg, V-neg
45	1280 × 960	SXGA VESA 60 Hz	60.000	60.000	H-pos, V-pos
46		SXGA VESA 75 Hz	75.000	75.000	H-pos, V-pos
47	1280 × 1024	SXGA VESA 60 Hz	63.974	60.013	H-pos, V-pos
48		SXGA VESA 75 Hz	79.976	75.025	H-pos, V-pos
49		SXGA VESA 85 Hz	91.146	85.024	H-pos, V-pos
50	1400 × 1050	SXGA+ 60 Hz	65.317	59.978	H-neg, V-pos
55	1280 × 768	WXGA 60Hz	47.776	59.870	H-neg, V-pos
56	1280 × 720	WXGA 60Hz	44.772	59.885	H-neg, V-pos
60	1360 × 768	1360 × 768/60	44.720	59.799	H-neg, V-pos
61	1440 × 900	1440 × 900/60	55.935	59.887	H-neg, V-pos
63	1280 × 800	1280 × 800/60	49.702	59.810	H-neg, V-pos

Notes

- The receivable digital signals are preset signals of Memory No. 3 to 11, 26, 32, 37, 45, 47, 50, 55 and 56.
- When a signal other than the preset signals shown above is input, the picture may not be displayed properly.
- When an SXGA+ signal is input, the image may extend beyond the edges of the screen. In this case, input a signal with no black edges around the image, and disconnect and reconnect the cable or select the input signal by pressing INPUT.
- If the resolution of the input signal is different from the panel resolution, the input signal is not displayed in its own resolution, and letters or lines may be uneven.

Installation Diagram

Floor Installation (Front Projection)

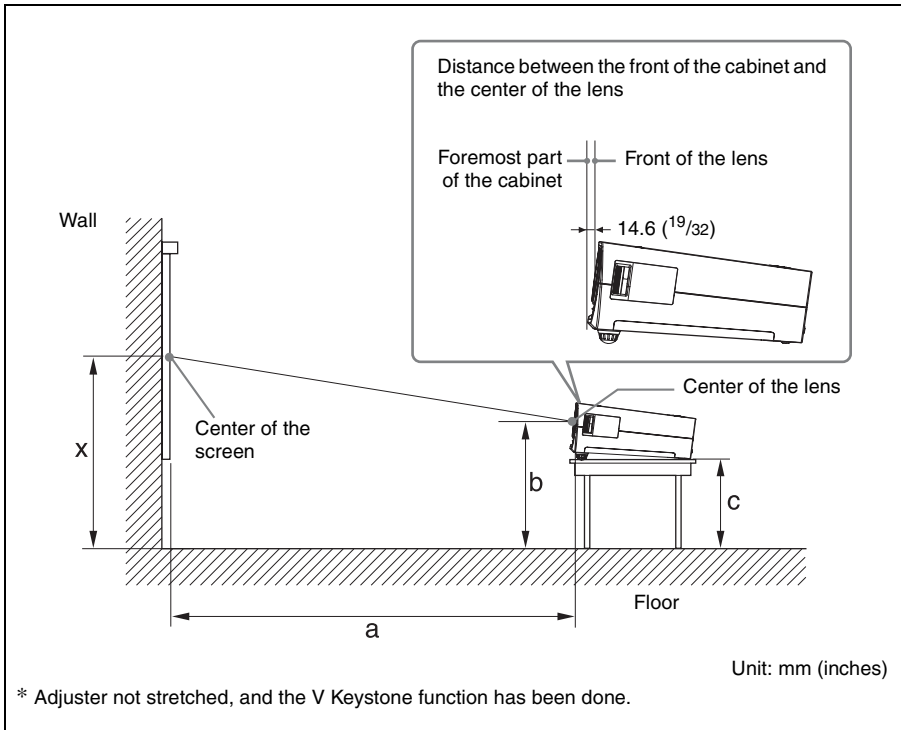

This section describes the examples of installing the projector on a desk, etc.

The alphabetical letters in the illustration indicate the distances below.

- a:** distance between the screen and the center of the lens
- b:** distance between the floor and the center of the lens
- c:** distance between the floor and the bottom of the adjusters of the projector
- x:** distance between the floor and the center of the screen (free)

When “Wide Mode” in the INPUT SETTING menu is set to “Full 2”

Unit: mm (inches)

PS		40	60	80	100	120	150	180	200	250	300
a	N	1250 (49 1/4)	1890 (74 1/2)	2530 (99 5/8)	3170 (124 7/8)	3810 (150 1/8)	4770 (187 7/8)	5730 (225 5/8)	6370 (250 7/8)	7970 (313 7/8)	9570 (376 7/8)
	M	1410 (55 3/8)	2140 (84 3/8)	2860 (112 5/8)	3580 (141)	4300 (169 3/8)	5390 (212 1/4)	6470 (254 7/8)	7200 (283 1/2)	9000 (354 3/8)	10810 (425 3/4)
b		Based on the calculation formula given below.									
c		Based on the calculation formula given below.									

$$a(N) = \{(PS \times 31.076) \times 1.03\} - 31.7$$

$$a (M) = \{ (PS \times 37.252) \times 0.97 \} - 31.7$$

$$b = x - \{ PS \times 4.465 + (a + 31.7) \times 0.1405 - 4.5 \}$$

$$c = x - \{ PS \times 4.465 + (a + 31.7) \times 0.1405 - 4.5 + 90.5 \}$$

Notes

- The projected image size is the one when “Wide Mode” in the INPUT SETTING menu is set to “Full 2”. When “Wide Mode” in the INPUT SETTING menu is set to the mode other than “Full 2”, black bands may appear at the top and bottom or right and left of the screen.
- When “Wide Mode” in the INPUT SETTING menu is set to “4:3”, the projected image size (diagonal) will be approximately 88 % of “Full 2” size.
- When “Wide Mode” in the INPUT SETTING menu is set to “16:9”, the projected image size (diagonal) will be approximately 97 % of “Full 2” size.

The alphabetical letters in the charts and calculation methods indicate the following.

- PS:** projected image size measured diagonally (inches)
a: distance between the screen and the center of the lens
b: distance between the floor and the center of the lens
c: distance between the floor and the adjusters of the projector
x: free
N: minimum
M: maximum

Ceiling Installation (Front Projection)

The unit is set so that the bottom is parallel to the ceiling. The V Keystone function has been done.

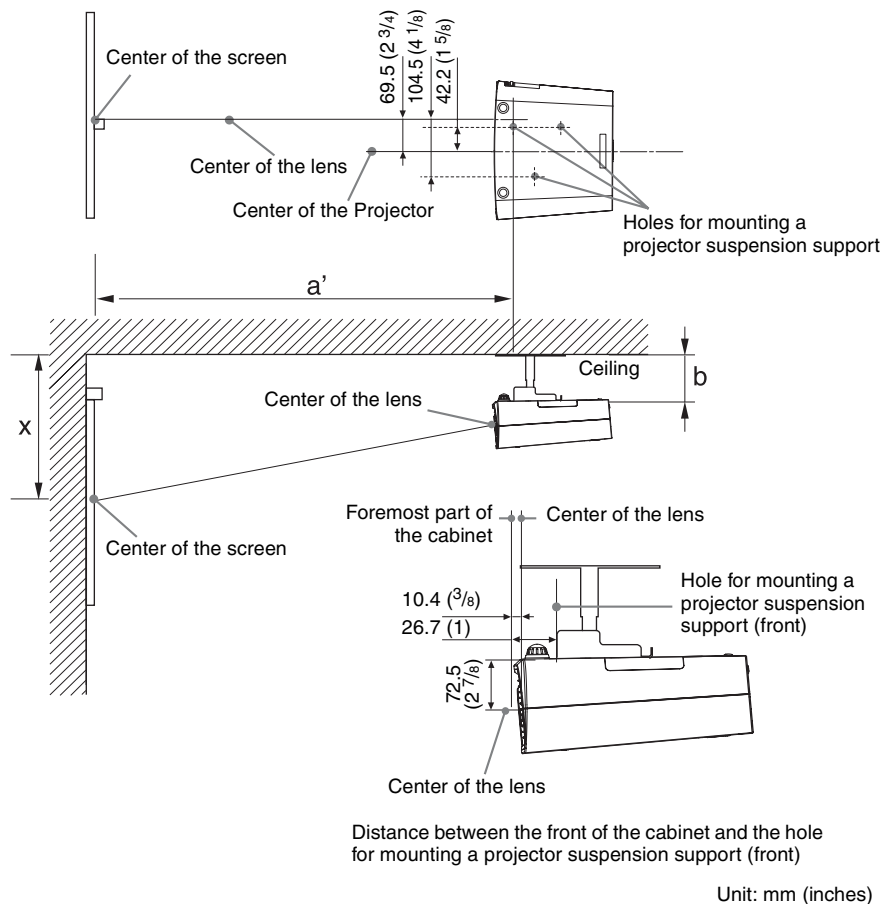

This section describes the examples for installing the projector on the ceiling.

When installing the projector on the ceiling, use a Projector Suspension Support recommended by Sony.

For ceiling installation, ask for qualified Sony personnel.

See the chart on page 59 concerning the installation measurements.

The alphabetical letters in the illustrations indicate the distances below.

a': distance between the hole (front) for mounting a projector suspension support on bottom surface of this projector and the center of the screen

b: distance between the hole (front) for mounting a projector suspension support on bottom surface of this projector and the ceiling

x: distance between the ceiling and the center of the screen

When “Wide Mode” in the INPUT SETTING menu is set to “Full 2”

Unit: mm (inches)

PS		40	60	80	100	120	150	180	200	250	300
a'	N	1270 (50)	1910 (75 1/4)	2550 (100 1/2)	3190 (125 5/8)	3830 (150 7/8)	4800 (189)	5760 (226 7/8)	6400 (252)	8000 (315)	9610 (378 1/2)
	M	1430 (56 3/8)	2160 (85 1/8)	2880 (113 1/2)	3610 (142 1/4)	4330 (170 1/2)	5420 (213)	6510 (256 3/8)	7230 (284 3/4)	9050 (356 3/8)	10860 (427 5/8)
x	Based on the calculation formula given below.										
b	Free										

$$a'(N) = \{(PS \times 31.147) \times 1.03\} - 32.0 + 16.4$$

$$a'(M) = \{(PS \times 37.367) \times 0.97\} - 32.0 + 16.4$$

$$x = b + \{PS \times 4.481 + (a' + 32.0 - 16.4) \times 0.07344 - 2.3 + 72.5\}$$

Notes

- The projected image size is the one when “Wide Mode” in the INPUT SETTING menu is set to “Full 2”. When “Wide Mode” in the INPUT SETTING menu is set to other than “Full 2”, black bands may appear at the top and bottom or right and left of the screen.
- When “Wide Mode” in the INPUT SETTING menu is set to “4:3”, the projected image size (diagonal) will be approximately 88 % of “Full 2” size.
- When “Wide Mode” in the INPUT SETTING menu is set to “16:9”, the projected image size (diagonal) will be approximately 97 % of “Full 2” size.

The alphabetical letters in the charts and calculation methods indicate the following.

PS: projected image size measured diagonally (inches)

a': distance between the hole (front) for mounting a projector suspension support on bottom surface of this projector and the center of the screen

b: distance between the projector suspension support mounting surface on bottom of this projector and the ceiling

x: distance between the center of the screen and the ceiling

N: minimum

M: maximum

Dimensions

Front

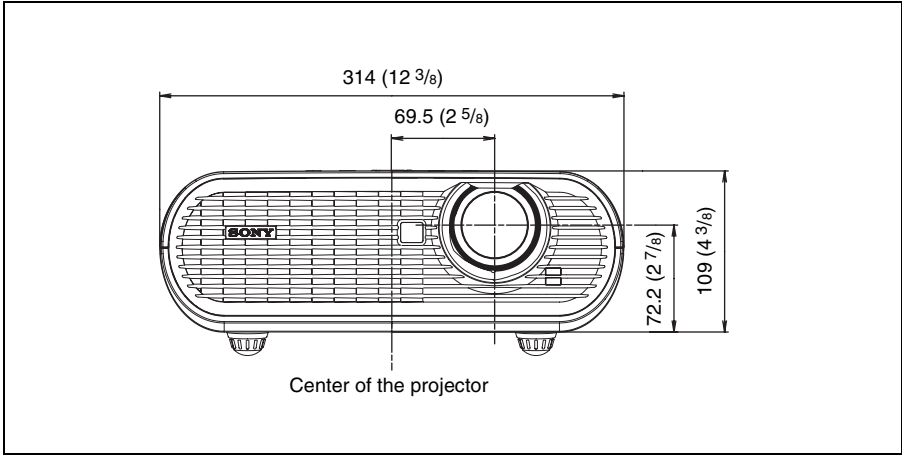

Unit: mm (inches)

Side

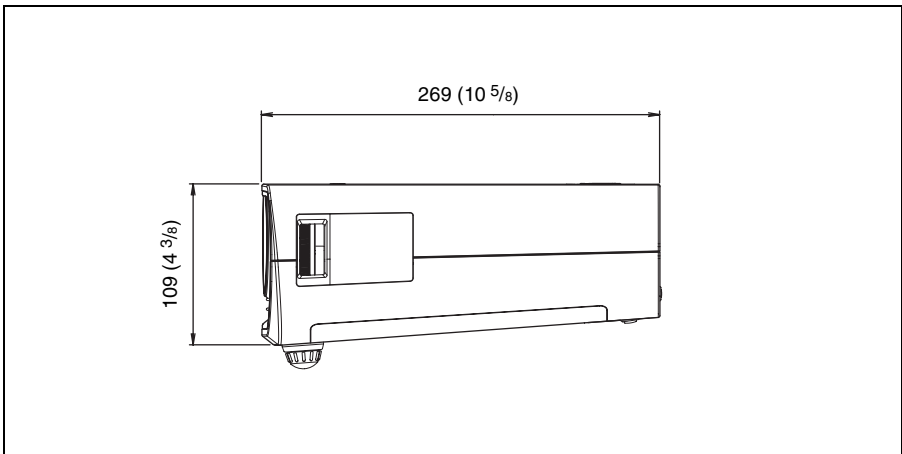

Unit: mm (inches)

Top

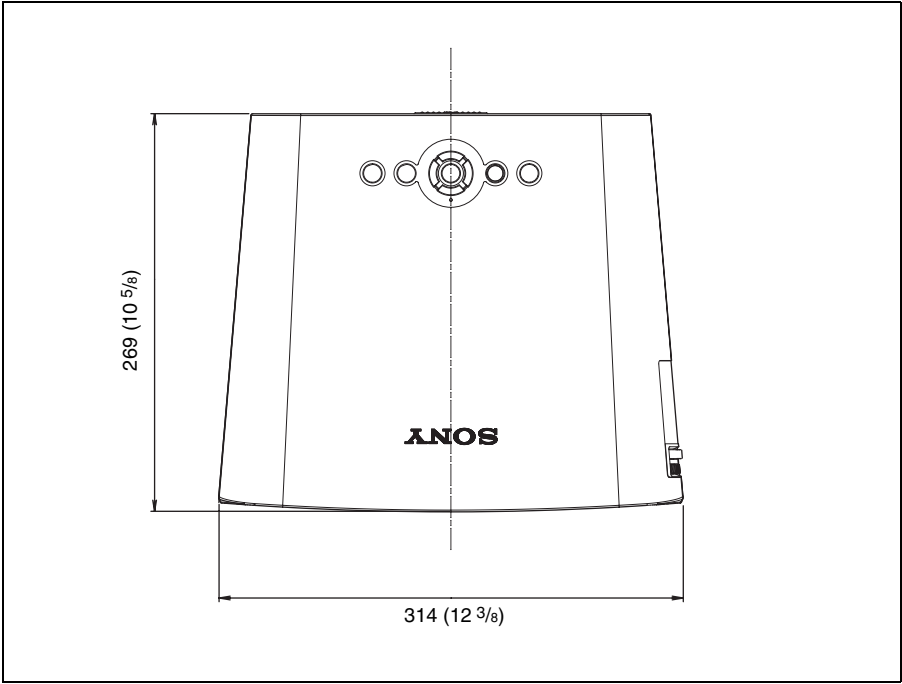

Unit: mm (inches)

Others

Index

A

Adjust Signal	
Dot Phase	37
H Size	37
Shift	37
Adjuster	23
Adjusting	
picture position	22
picture quality	31
Auto Input Search	39

B

Background	42
Brightness	36

C

Color	36
Color System	40
Color Temp.	36
Connecting	
Computer	21
Video equipment	18
Contrast	35

D

DDE	36
-----------	----

F

fH	44
fV	44

G

Gamma Mode	36
------------------	----

H

HDMI	18
High Altitude Mode	42
Hue	36

I

Image Flip	42
Input-A Signal Sel.	39
Installation	
Ceiling	58
Floor	56

unsuitable conditions	14
unsuitable installation	13
IR Receiver	40

L

Lamp Mode	42
Lamp replacement	49
Lamp Timer	44
Lamp Timer Reset	40
Language	41
selecting the menu language	24
Location of Controls	
Rear/Bottom	8
Top/Front/Side	6

M

Menu	
INFORMATION Menu	44
INPUT SETTING menu	37
INSTALL SETTING menu	42
MENU SETTING menu	41
PICTURE SETTING menu	35
SET SETTING menu	39
Message List	48

O

Optional accessory	53
Over Scan	38

P

Picture Mode	
CINEMA	30
Cinema	35
DYNAMIC	30
Dynamic	35
STANDARD	30
Standard	35
USER	30
User	35
Pin assignment	53
Power	
turn on	27
Power Saving	40
Precautions	5
Preset Memory	38
Preset Signals	54
Projecting	26

R

Remote control	
----------------	--

inserting the batteries	12
location of controls	10
Reset	
resettable items	34
resetting the items	34

S

Security bar	9
Sharpness	36
Smart APA	39
Start Up Image	41
Status	41
Supplied accessories	12

T

Troubleshooting	46
-----------------------	----

V

V Keystone	42
------------------	----

W

WIDE MODE	28
Wide Mode	
Full	37
Full 1	38
Full 2	38
Normal	37
Wide Zoom	37
Zoom	37

<http://www.sony.net/>

Sony Corporation Printed in China